

# PMC<sup>®</sup>

## active twenty5

User guide

No.

Hand built by

- active twenty5 
- active twenty5 
- active twenty5 
- active twenty5 



# IMPORTANT



## WARRANTY

### **Warranty**

Please take a few moments to complete the warranty card at the back of this booklet or register at [www.pmc-speakers.com](http://www.pmc-speakers.com) (click on 'register a product'). This records the purchase of your loudspeakers and provides you, the customer an opportunity to make suggestions and provide feedback directly to PMC. To gain your 5 year warranty your product must be registered with us within 10 days of purchase.

### **Product Support**

For product support, accessories or servicing advice, please contact a PMC authorised retailer – See [www.pmc-speakers.com/where-to-buy](http://www.pmc-speakers.com/where-to-buy)

## **THE PROFESSIONAL MONITOR COMPANY LIMITED**

HOLME COURT, BIGGLESWADE, SG18 9ST, UK

T +44 (0) 1767 686300

[sales@pmc-speakers.com](mailto:sales@pmc-speakers.com)

[www.pmc-speakers.com](http://www.pmc-speakers.com)

© 2024 PMC. All rights reserved.

Ref No: 1309

PMC Stock Code: 16746



twenty5.21*i* in Diamond black



# WHAT DRIVES US

At PMC, we believe that music is what really matters; it's what moves us and gives us the passion for what we do.

It's relatively easy to create loudspeakers that colour or flatter music — but that has never been our way. The quest for sonic neutrality and transparency has always been PMC's obsession, using advanced engineering to reproduce music as vividly and faithfully as possible. Our designs are involved in every stage of music-making, from the recording studio to listening at home. From this experience, we know exactly how to present music as transparently as possible, just as the artist intended.

As we like to say, loudspeakers are where science meets art — we take care of the science so you can connect with the art.



Peter Thomas, Owner &  
Oliver Thomas, Chief Technical Officer

# CONGRATULATIONS – YOU HAVE JOINED THE ELITE

**Stevie Wonder**

You have joined the elite. You're a PMC user.

**UNIVERSAL MUSIC GROUP**

**ESPN**

Our loudspeakers can be found in all the world's best listening environments, from audiophile living rooms to internationally renowned recording, mastering, broadcast and post-production studios. Our Emmy-award-winning systems are used to create everything from smash Hollywood soundtracks to hit albums by artists including Coldplay, Kraftwerk, Elton John and Adele, as well as audiophile jazz and classical recordings on Deutsche Grammophon, Decca, Philips and Harmonia Mundi.

**Thomas Newman**

**BBC**

*Arcjacek*

**Elton John**

**Kraftwerk**

**Apple**

*Royal College of Music*

**EMI**

**Warner Music**

**SONY**

Whether you listen to our speakers in world-class studios in LA, London, Berlin or Tokyo, or in your favourite listening room at home, you will hear the music exactly as the artist intended it.

**Pinewood Studios**

**Coldplay**

*Capitol Studios*

**elbow**

**JOHN NEWMAN**

# CONTENTS

- 9 General usage guidelines
- 10 Introduction
- 11 System description
- 12 PMC's **ATL™** (Advanced Transmission Line)
- 13 **Laminair™**
- 14 Our meticulous attention to detail
- 15 Unpacking
- 18 Installing the resonance-absorbing plinth bars
- 19 Dedicated **twenty5i** series stands
- 20 Connections and Controls - plugging them in
- 21 Running in or breaking in
- 22 Positioning
- 24 Fine tuning for perfect bass
- 25 Stereo set up
- 26 Surround sound specific set up
- 27 Ideal 5.1 surround sound set up
- 28 Ideal 7.1 surround sound set up
- 29 Service
- 30 Specifications
- 33 Warranty on-line
- 34 Warranty certificate – Part 1 – Your copy
- 35 Warranty certificate – Part 2 – Our copy
- 36 Help us improve – Your comments
- 37 Inspection certificate



# GENERAL USAGE GUIDELINES

- 1 Read these instructions and keep them in a safe place for future reference.
- 2 Heed all electrical safety warnings, including any on the loudspeakers themselves.
- 3 Do not use the loudspeakers near water.
- 4 The cabinet should only be cleaned with a dry, lint-free, cloth. Do not use solvents, abrasives, waxes or liquids as they may be detrimental to the finish.
- 5 Free flow of air behind the loudspeaker is necessary to maintain sufficient cooling. Do not inhibit airflow around the unit.
- 6 Floor spikes are sharp; treat with great care during installation and use.
- 7 This unit must be earthed. Do not use the loudspeaker with an unearthed mains cable or an unearthed mains connection as this may compromise electrical safety. A suitable mains cable is supplied with the product.
  - Apparatet må kun tilkoples jordet stikkontakt
  - Laite on liitettävä suojamaadoituskoskettimilla varustettuun pistorasiaan
  - Apparaten skall anslutas till jordat uttagt
  - Apparatets stikprop skal filsluttes en stikkontakt med jord, som giver forbindelse til stikproppens jord
- 8 The amplifier is not disconnected from the mains supply unless the power cord is removed from the unit or the mains outlet.
- 9 Protect the power cord from being walked on or pinched particularly at plugs, sockets, inlets and outlets.
- 10 Do not install near any heat sources such as radiators, ovens or other equipment that produce excessive heat and avoid positioning the speaker where it could be subject to the heating effects of direct sunlight.
- 11 Unplug this product from both source and power during electrical storms, or when unused for extended periods of time.
- 12 Packing material can pose danger to the young and vulnerable. Ensure these items are kept or disposed of safely.
- 13 High volume audio signals, however short their duration, have the potential to cause hearing damage. Use care when setting the system volume level to ensure playback sound pressure levels remain within safe comfortable limits.

# GENERAL USAGE GUIDELINES

- 14 Do not attempt to service the equipment. There are no user serviceable parts inside. Please refer all servicing to PMC authorised personnel.
- 15 Servicing is required when the apparatus is damaged, exposed to moisture, or exhibits a distinct or sudden change of operation or audio performance.
- 16 PMC has made efforts to provide accurate installation information and good quality fixings. PMC will not be held responsible or liable for injuries or property damage – direct, indirect or consequential – arising out of use or inability to use this product safely and properly.
- 17 **twenty5i** loudspeakers contain very powerful magnets and therefore may have a detrimental effect if left in close proximity to magnetically sensitive items.
- 18 Do not use the **Laminair** vent as a grip to lift the loudspeaker as this may result in damage.



***This unit must be earthed.***

***Do not attempt to use these speakers if the packaging has been water-damaged***

## INTRODUCTION

Thank you for choosing PMC. This guide provides installation and operating instructions for the **twenty5i** active loudspeakers.

These loudspeakers build upon PMC's world-class design pedigree, combining the finest drivers available with the unique **ATL™** (Advanced Transmission Line) bass-loading principle, sophisticated Class-D amplification and a pure analogue active crossover.

PMC's unique **ATL™** technology uses contemporary materials to provide optimised absorption of unwanted mid-range energy within the cabinet, while extending bass output significantly with negligible harmonic distortion.

The electronics built into each cabinet provide two channels of ultra-low distortion Class-D power amplification, with a pure analogue 24dB-per-octave crossover providing perfect driver optimisation and integration. A transparent protection system is also included.

# SYSTEM DESCRIPTION

The audio enters the loudspeaker via a balanced or unbalanced low-noise, high-performance analogue input, and the signal path through the loudspeaker and independent power amplifier has been designed to be as short as possible to maintain these qualities throughout.

A total of 200W of high-efficiency amplification is provided, with 100W for the high-frequency driver and 100W for the bass unit. The amplifier design ensures that driver impedance variations with frequency are fully compensated to maintain a uniform frequency response.

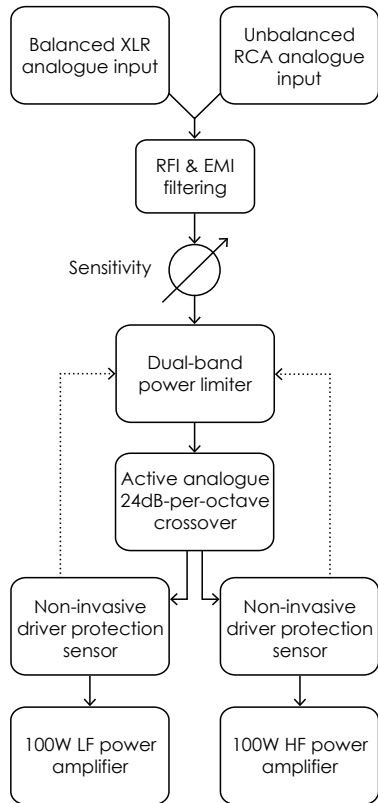

# ATL™

## Advanced Transmission Line

The source of PMC's legendary natural and wholly realistic sound is the Advanced Transmission Line (**ATL™**) bass-loading technology.

**ATL™** is an ingenious design which uses energy generated by the bass unit in a much more intelligent and efficient way than speaker designs based on ported or sealed boxes.

In **ATL™** loudspeakers, the highly braced cabinet is lined with a multitude of custom-designed acoustic materials that absorb all but the very lowest frequencies. These are guided to exit from a vent on the front-panel, extending the low-frequency response and creating the impression of a far larger speaker with an extra, ultra-high quality bass unit.

**ATL™** improves more than just the bass response: because the low end is clean and clear it doesn't mask the rest of the music. Vocals in particular, are beautifully projected and ultra-vivid.

**ATL™** loudspeakers offer another benefit. The **ATL™** bass extension does not change with volume level – so even when listening quietly the bass sounds balanced and well defined.

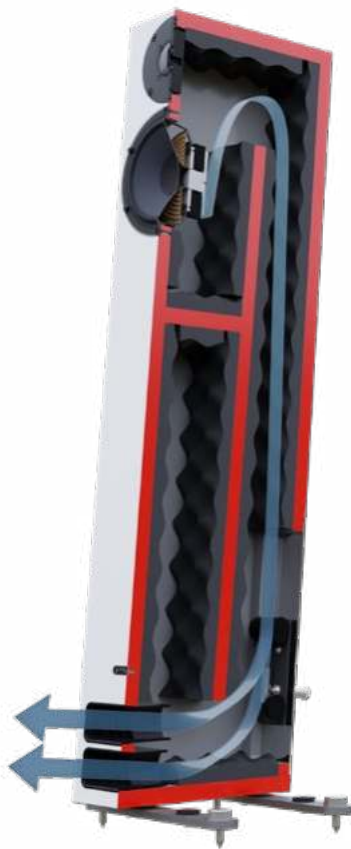

This cross-sectional view of the **twenty5.24i** loudspeaker shows the **ATL™** cabinet arrangement and the unique **Laminair™** vents



Our loudspeaker performance has been taken to the next level with the addition of the **Laminair™** aerodynamic vent.

The **ATL™** design involves air moving under pressure at high speeds, and PMC's Head of Design, Oliver Thomas was able to apply aerodynamic principles transferred from his previous industry, Formula 1 to the **ATL™** concept.

The result is the unique **Laminair™** aerodynamic vent which creates an even smoother, laminar airflow at the exit from the transmission line.

This innovative solution reduces turbulence and drag at the **ATL™** vent, reducing resistance, increasing efficiency, eliminating air noise, and provides bass with supreme timing and the ultimate dynamic range.

**'Nothing else comes close to the clarity, timing, and dynamics.'**



## OUR METICULOUS ATTENTION TO DETAIL

All PMC loudspeakers are designed and hand-built in the U.K. using individual components that are matched to our reference model; this includes the structural integrity of every cabinet and the testing and recording of each component. This guarantees it will be within our strict tolerances and ensures your purchase sounds identical to the original design. Each completed loudspeaker then undergoes a set of objective and subjective measurements - frequency response sweeps ensure that the design meets our exacting performance criteria, and then listening tests are conducted against the reference model using a wide variety of material, from a benchmark BBC speech test to classical music, pop and rock.



“ Computers don't tell the full story. As well as a full frequency analysis, we listen to each speaker we make and run a benchmark BBC speech and music test on every single one. ”

# UNPACKING

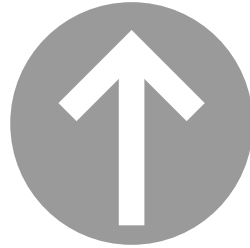

Please retain your packaging for future use as all PMC cartons are durable, reusable and can be employed to safely transport your loudspeakers should they be relocated or returned for servicing.

Much of the packing is constructed from recyclable materials, so if you are to dispose of it please do so in an environmentally friendly manner.



Packing materials can pose danger to animals, the young and vulnerable. Ensure these items are kept or disposed of safely.

active **twenty5** 21i

active **twenty5** 22i

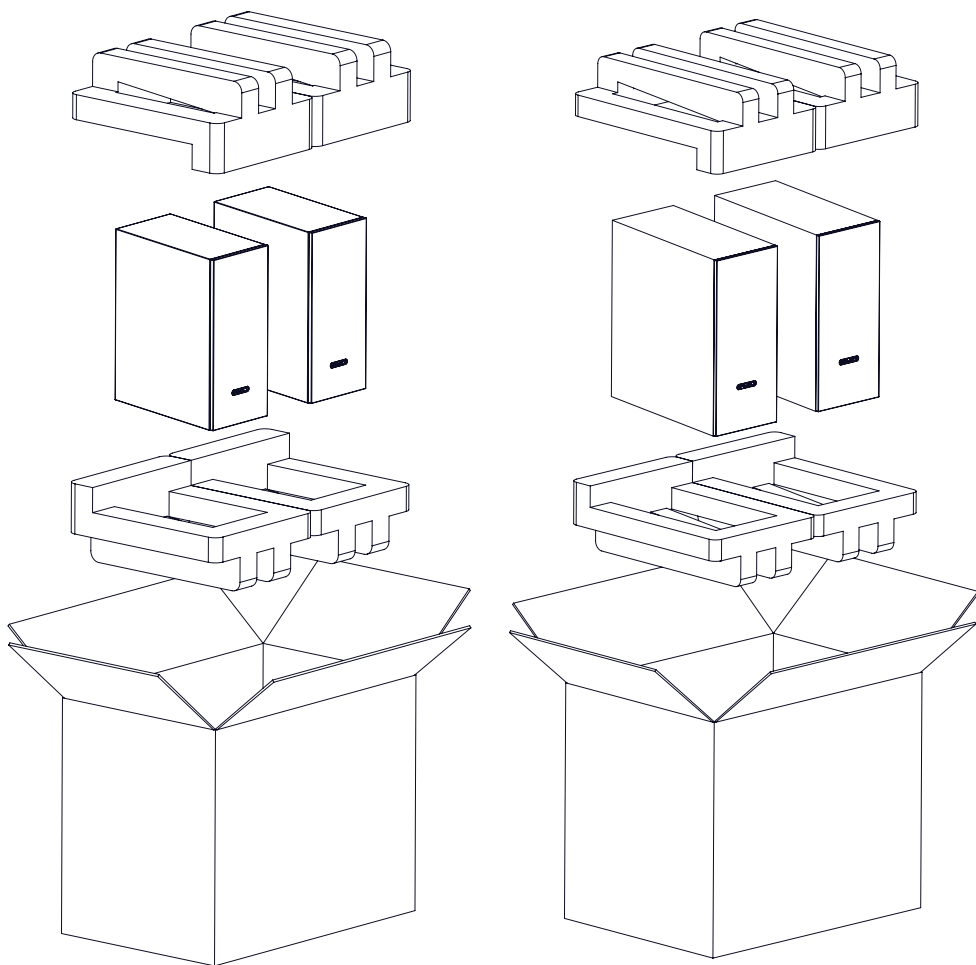

### Re-packing

When re-packing all **twenty5i** series models ensure the grilles are in their protective bags and attached to the cabinet.

**TAKE CARE WHEN UNPACKING – THERE ARE DELICATE  
TERMINALS ON THE REAR OF THE CABINET**



active **twenty5** 23*i*

active **twenty5** 24*i*

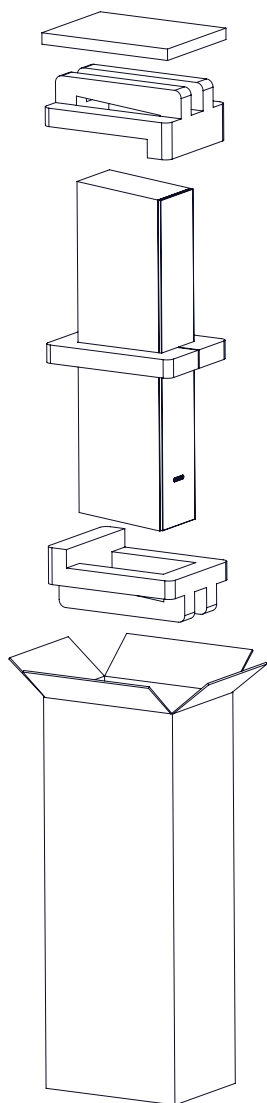

### Re-packing

When re-packing all **twenty5i** series models ensure the grilles are in their protective bags and attached to the cabinet.

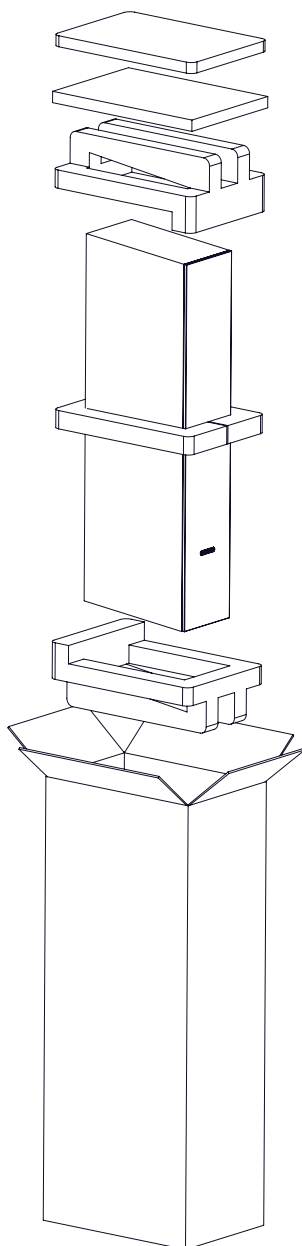

STEADY THE LOUDSPEAKER CABINET WHILE REMOVING THE CARTON

# INSTALLING THE RESONANCE-ABSORBING PLINTH BARS

Plinth bars and spikes are provided to enhance performance and stability. They attach to the base of each speaker using M8 bolts and are isolated from both the cabinet and floor by isolator rings of a very specific compliance.

- 1 Ensure isolator rings are placed in the rebates in the plinth bars.
- 2 Place an isolator ring over each mounting hole on the base of the cabinet.
- 3 Place the plinth bars on the speaker ensuring all the holes are aligned and ready to take the M8 bolts.
- 4 Locate the M8 bolts and tighten them **gently** using the Allen/hex key provided until they are seated but not tightened.
- 5 Once the bolts are all seated, tighten each bolt **carefully** by **half a turn**. **Do not over-tighten the bolts**. Over-tightening will reduce the effect of the resonance-absorbing material and the performance of the speaker.
- 6 Fully thread each spike through the plinth bar. The spikes can then be attached to the plinth; they should point upwards whilst the cabinet is inverted.
- 7 Re-invert the loudspeaker so that the spikes and plinth bars are at the bottom.
- 8 Once in position, level the loudspeaker by adjusting each spike in turn.



**Caution:** The spikes are sharp, treat them with care; they may damage hard flooring if in direct contact. We have included pucks to protect sensitive or hard flooring.

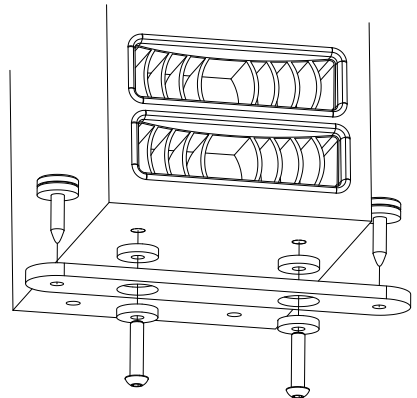

# DEDICATED STANDS

The **twenty5i** series compact models are designed to offer exceptional clarity while taking up minimal space, and can be used either on stands or within audio/video furniture.

However, they will realise their optimum performance when used in conjunction with PMC's dedicated high-mass stand that positions them at the ideal height and with complete stability.

## Stand Features

- Unique, damped, 3-layer sandwich construction.
- Mass fill-able – sand or shot.
- Built-in cable management.
- Essential to complete the dynamic **twenty5i** series look.



## Stand Dimensions

**H** 599mm +25mm spikes

**W** 229mm

**D** 364mm



# CONNECTIONS

## Caution

To avoid potential damage, please ensure that the signal source is turned off before connecting or disconnecting your **twenty5i** active loudspeakers.

### 1 Audio

The active **twenty5i** models feature two types of audio input – electronically balanced XLR and unbalanced RCA. Only one input should be connected at a time.

### 2 Power

The IEC (C14) mains socket is provided adjacent to the power switch. There is no AC voltage selector; the active **twenty5i** loudspeaker can accept any AC mains voltage between 100-240V.

# CONTROLS

### 3 LED indicator

In normal operation when the unit is powered and switched on the rear-panel LED indicator will be lit green. Flashing red indicates that the driver protection system is in play. If this happens, reduce the input level. Continuous red or blue indication denotes a fault – please contact your authorised dealer for assistance.

### 4 Sensitivity Switch

The sensitivity switch can be used to adjust the overall loudspeaker gain to suit your source equipment. Switching from the default high setting to the low setting reduces the gain by

20 10dB, suitable for particularly loud signal sources.

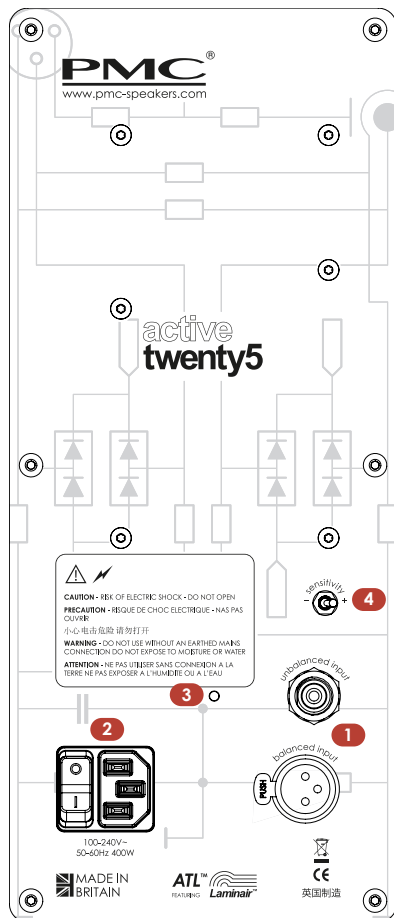

**THIS UNIT MUST BE EARTHED**

## RUNNING IN OR BREAKING IN



50  
HOURS

When loudspeakers are new they will take time to reach their full potential. It is often debated whether any solid-state equipment, such as CD players or transistor-based power amplifiers change with use, but the characteristics of mechanical devices such as loudspeakers do alter and improve their performance significantly after a short 'running in' period.

The science is simple; as the soft material surrounding the dome or woofer cone is flexed it will eventually reach a point where it has optimum compliancy allowing the drive unit to move more freely. This translates to greater accuracy and speed of attack in the bass region and the mid and high frequency produces a far more vivid audio picture. This short 'running in' period takes approximately 50 hours of normal use.

# 50+ hours to run-in

# POSITIONING

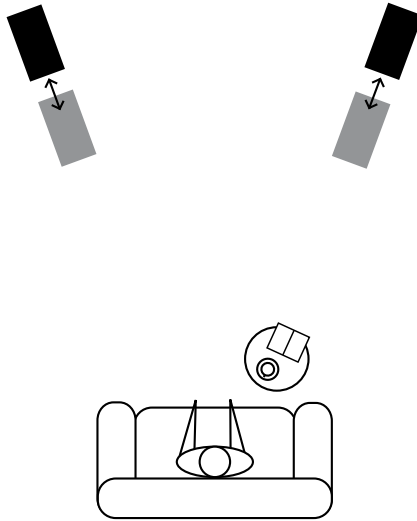

With their unique **ATL™** Advanced Transmission Line design, wide dispersion, ultra low distortion and smooth bass roll-off, PMC loudspeakers are more forgiving of difficult room conditions and placement constraints than conventional designs so you will be able to achieve a superb sound throughout the room with little effort. We do encourage you to spend some time experimenting in your own room in order to achieve the very best results. Remembering that small changes in location can often influence system performance.

Room shape, size, construction and interior decoration vary immensely and therefore influence sound in different ways. The following guidelines are suggestions for the starting point to locate your new speakers. Fine-tuning of their positioning can start from here.

# POSITIONING

- Place the speaker so the front face is slightly forward of any large object that protrudes into the room – eg. a fireplace, bookcase or television.

**TIP** – See stereo set up diagram

- Ensure that stereo pairs of loudspeakers are equidistant from the listening position.
- It is best to position the front left/right pair (and centre channel loudspeaker if you have a surround system) at the same height, usually at ear-level when seated at the listening position.

**TIP** – If any of the speakers are mounted above or below ear level, then angle the speaker towards the listening position.

- The distance between your left/right speakers and the listening position should ideally be equal. As a general rule, the width of the audio picture will be narrow if the speakers are too close together. If they are too far apart the picture will be wide but there will be less central definition.

**TIP** – Use a well recorded vocal track to judge the ideal spot.

- To enhance the audio picture/soundstage and sound balance, the speakers can be angled/toed-in. With the speakers facing straight ahead play a well recorded vocal track. Gradually toe-in both speakers by small increments (max 5° at a time) (see stereo set-up diagram) until the voice is vivid and centrally placed. You can ensure this is best position by going 'one step too far' then returning. Then, use a track with extended high frequencies such as cymbals, check that they sound clear but not overpowering. If they sound too loud or harsh subtly toe the speakers out by very small increments until you achieve the ideal balance; then repeat both listening tests to confirm.

**TIP** – A simple, well-recorded band with vivid vocals will help to find the best position.

# FINE TUNING FOR PERFECT BASS

## Bass / LF (Low Frequency adjustment)

Solid boundaries (i.e. walls, ceilings and floors) reflect sound and help to contain it within a room. They make a speaker sound louder the closer they are to them, especially in the low frequency (bass) region.

This diagram shows the areas, that if a speaker is positioned, will either increase or decrease bass – The darker the shading the more bass will be heard. Placing the speakers in the corners will generate the most bass, and in the centre of the room, the least bass.

Fine tuning for perfect bass

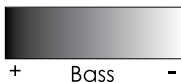
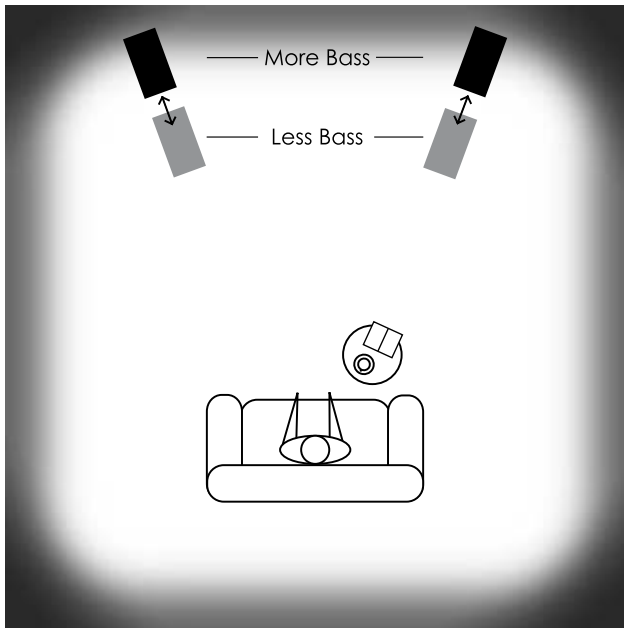



# STEREO SET UP

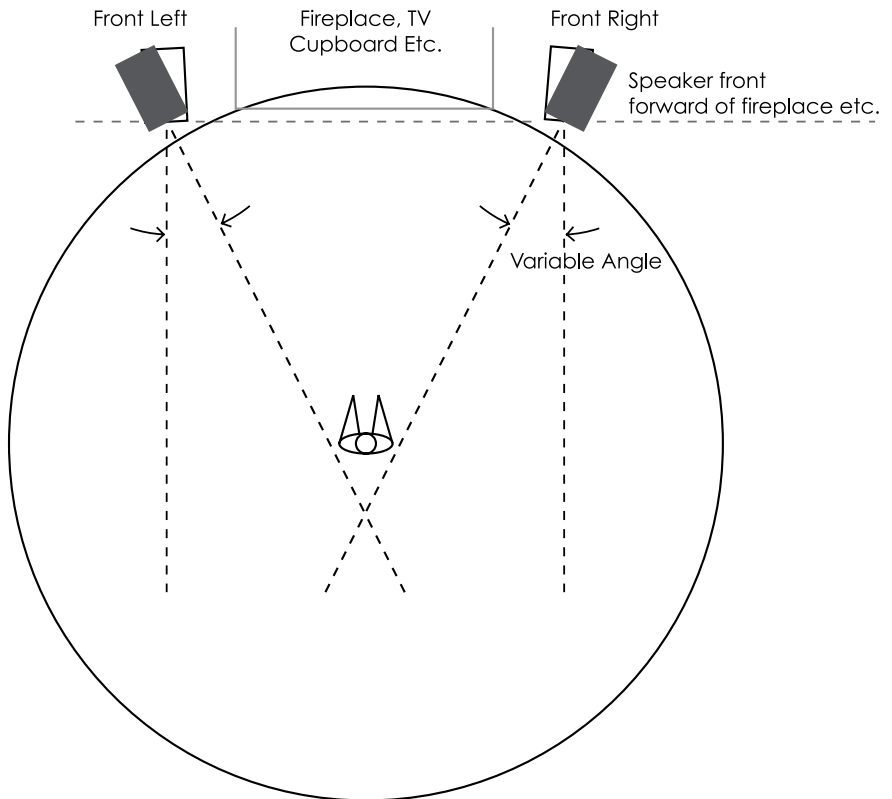

# SURROUND SOUND SPECIFIC SET UP

## 5.1 Systems

The **twenty5i** series has been designed for perfect multi channel music or movie playback and the following diagrams display the ideal layout for the speakers.

**TIP** – No doubt the constraints of room size and shape will vary the distances from the listener to the speakers. Therefore use of the time alignment function of your surround processor will be important.

**TIP** – The guidance given in the 'Stereo set up' and 'Fine tuning for perfect bass' also apply to the set up of a surround system.

## 7.1 Systems

In a system capable of full 7.1 Dolby® Digital Surround EX™, DTS® ES™, Blu-ray™ or HD DVD™ playback there will be two sets of surround speakers. The first pair should be positioned at 100° and the second set at 150°. (The centre is considered 0° while directly to the rear of the room is 180°). See Ideal 7.1 surround set up diagram.

## Other Immersive Surround Formats

DTS:X™, Dolby Atmos™, Auro 3D® – we have models to suit every format. With our vast array of product options it is easy to create a bespoke state-of-the-art home cinema to take full advantage of the latest surround sound formats, regardless of the number of channels or placement of the speakers. In addition to the choices from the **twenty5i** series we produce in-wall and on-wall **ci** series models and both active and passive subwoofers. See [www.pmc-speakers.com](http://www.pmc-speakers.com) for more information.

Dolby® Digital Surround EX™ and Dolby Atmos are registered trademarks of Dolby® Laboratories  
DTS® ES™ and DTS:X™ are registered trademarks of DTS®, Inc  
Auro 3D® is a registered trademark of Aurio Technologies  
Blu-ray™ is a trademark of the Blu-ray™ Disc Association  
HD DVD™ is a trademark of the DVD Format/Logo Licensing Corporation (DVD FLLC)

# IDEAL 5.1 SURROUND SET UP

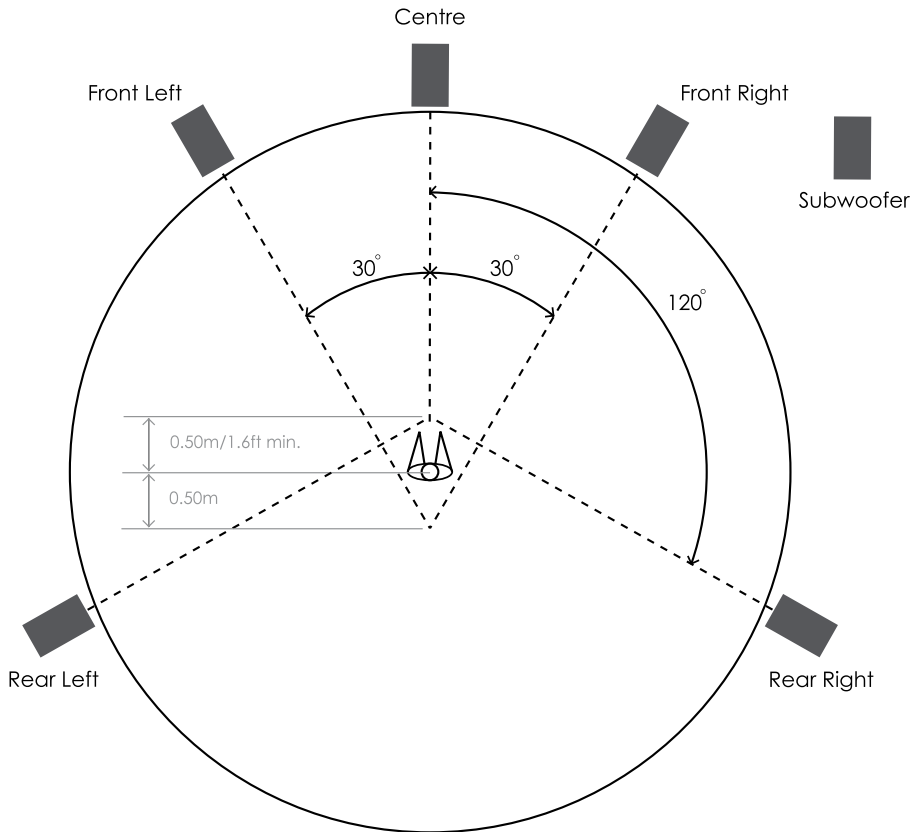

# IDEAL 7.1 SURROUND SOUND SET UP

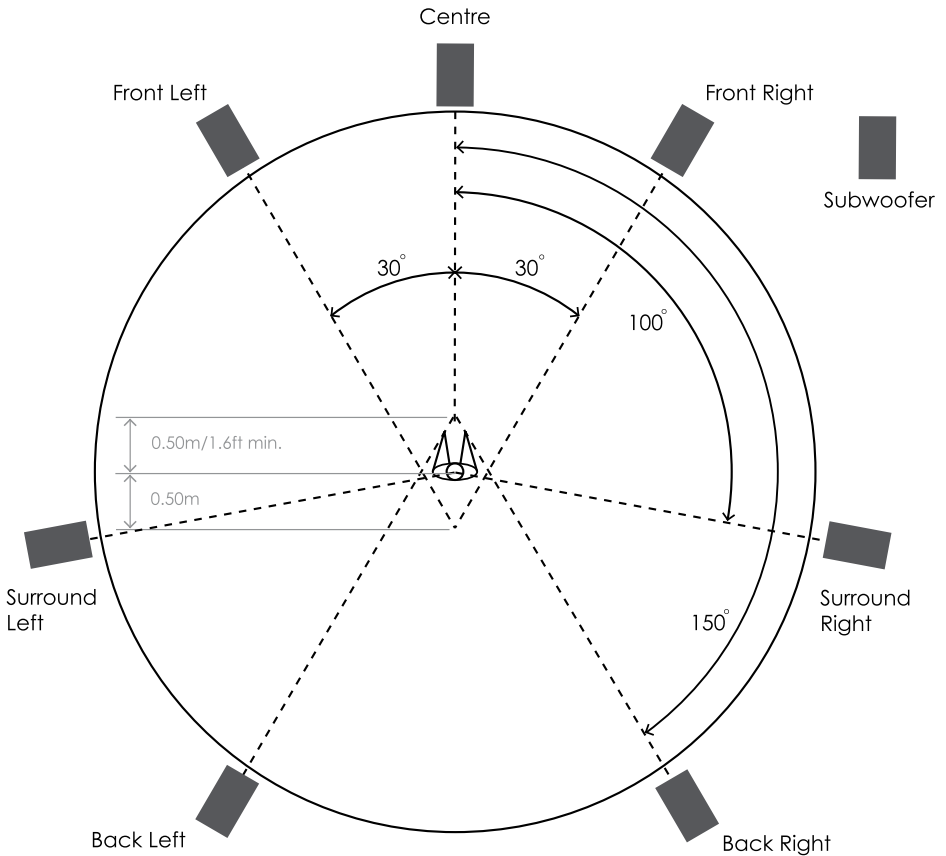

For the Dolby Atmos™ system height channels are required. We produce a range of products to accommodate this. See [www.pmc-speakers.com](http://www.pmc-speakers.com)

# SERVICE

We are confident your **twenty5i** loudspeakers will afford many years of trouble-free listening of the highest order. But in the unlikely event that one or more requires repair, our unique manufacturing procedure, wherein the precise value of each component together with the response of the system as a whole is recorded, will ensure that any replaced parts will exactly match the performance of those originally included within each individual loudspeaker.

For any issues that might arise, or for advice and service requirements, the primary point of contact should be your knowledgeable and authorised PMC dealer/distributor.

If you do not have a local representative please see [www.pmc-speakers.com](http://www.pmc-speakers.com) and click on 'where to buy'.

Alternatively you can view our FAQ's (Frequently Asked Questions) and servicing section on our website. (Click on the contacts section and select FAQ).



**Important Note:** Please do not return any products to PMC directly without first contacting our service department.

# SPECIFICATIONS

## active twenty5

<b>Frequency Response</b>	46Hz – 25kHz
<b>Effective ATL™ Length</b>	1.72m (5.6ft)
<b>Drive Units</b>	<b>LF</b> PMC 5.5" / 140mm long-throw <b>g-weave™</b> cone with cast alloy chassis <b>HF</b> PMC/SEAS®, 19mm <b>twenty5i</b> series, SONOMEX™ fabric soft dome, Ferrofluid cooled, with 34mm surround and dispersion grille
<b>Crossover Frequencies</b>	1.65kHz
<b>Horizontal Directivity</b>	100 Degrees
<b>Vertical Directivity</b>	90 Degrees
<b>Input connectors</b>	Balanced analogue XLR and unbalanced RCA
<b>Amplifiers</b>	HF 100Wrms + LF 100Wrms
<b>Gain/Sensitivity</b>	1Vrms = 96.5dB SPL @ 1m (low setting) / 106.5dB SPL @ 1m (high setting)
<b>Input impedance</b>	>14kΩ
<b>Mains power</b>	90-260V, IEC C14 Connector
<b>Dimensions</b>	<b>H</b> 340mm (13.4") <b>W</b> 162mm (6.4") <b>D</b> 269mm (10.6") including connectors (+ 9mm grille)
<b>Weight</b>	6kg (13.2 lbs) each

## active twenty5

<b>Frequency Response</b>	39Hz - 25kHz
<b>Effective ATL™ Length</b>	2m (6.5ft)
<b>Drive Units</b>	<b>LF</b> PMC 6.5" / 170mm long-throw <b>g-weave™</b> cone with cast alloy chassis <b>HF</b> PMC/SEAS®, 19mm <b>twenty5i</b> series, SONOMEX™ fabric soft dome, Ferrofluid cooled, with 34mm surround and dispersion grille
<b>Crossover Frequencies</b>	1.75kHz
<b>Horizontal Directivity</b>	90 Degrees
<b>Vertical Directivity</b>	90 Degrees
<b>Input connectors</b>	Balanced analogue XLR and unbalanced RCA
<b>Amplifiers</b>	HF 100Wrms + LF 100Wrms
<b>Gain/Sensitivity</b>	1Vrms = 99dB SPL @ 1m (low setting) / 109dB SPL @ 1m (high setting)
<b>Input impedance</b>	>14kΩ
<b>Mains power</b>	90-260V, IEC C14 Connector
<b>Dimensions</b>	<b>H</b> 410mm (16.1") <b>W</b> 192mm (7.6") <b>D</b> 357mm (14") including connectors (+ 9mm grille)
<b>Weight</b>	10kg (22 lbs) each

# SPECIFICATIONS

## active twenty5

<b>Frequency Response</b>	28Hz – 25kHz
<b>Effective ATL™ Length</b>	2.4m (7.8ft)
<b>Drive Units</b>	<b>LF</b> PMC 5.5" / 140mm long-throw <b>g-weave™</b> cone with cast alloy chassis <b>HF</b> PMC/SEAS®, 19mm <b>twenty5i</b> series, SONOMEX™ fabric soft dome, Ferrofluid cooled, with 34mm surround and dispersion grille
<b>Crossover Frequencies</b>	1.75kHz
<b>Horizontal Directivity</b>	90 Degrees
<b>Vertical Directivity</b>	90 Degrees
<b>Input connectors</b>	Balanced analogue XLR and unbalanced RCA
<b>Amplifiers</b>	HF 100Wrms + LF 100Wrms
<b>Gain/Sensitivity</b>	1Vrms = 96.5dB SPL @ 1m (low setting) / 106.5dB SPL @ 1m (high setting)
<b>Input impedance</b>	>14kΩ
<b>Mains power</b>	90-260V, IEC C14 Connector
<b>Dimensions</b>	<b>H</b> 907mm (35.7") (+20mm spikes) <b>W</b> 162mm (6.4") (238mm incl. plinth bars) <b>D</b> 330mm (13") (+9mm grille)
<b>Weight</b>	15kg (33 lbs) each

## active twenty5

<b>Frequency Response</b>	27Hz - 25kHz
<b>Effective ATL™ Length</b>	3m (9.8ft)
<b>Drive Units</b>	<b>LF</b> PMC 6.5" / 170mm long-throw <b>g-weave™</b> cone with cast alloy chassis <b>HF</b> PMC/SEAS®, 19mm <b>twenty5i</b> series, SONOMEX™ fabric soft dome, Ferrofluid cooled, with 34mm surround and dispersion grille
<b>Crossover Frequencies</b>	1.9kHz
<b>Horizontal Directivity</b>	90 Degrees
<b>Vertical Directivity</b>	100 Degrees
<b>Input connectors</b>	Balanced analogue XLR and unbalanced RCA
<b>Amplifiers</b>	HF 100Wrms + LF 100Wrms
<b>Gain/Sensitivity</b>	1Vrms = 99dB SPL @ 1m (low setting) / 109dB SPL @ 1m (high setting)
<b>Input impedance</b>	>14kΩ
<b>Mains power</b>	90-260V, IEC C14 Connector
<b>Dimensions</b>	<b>H</b> 1015mm (40") (+20mm spikes) <b>W</b> 192mm (7.6") (275mm Incl. plinth bars) <b>D</b> 419mm (16.5") (+9mm grille)
<b>Weight</b>	23kg (50.6 lbs) each

\* Subject to change without notice



PMC

PMC

twenty5.21i in Walnut



# WARRANTY ONLINE

Register within 10 days to unlock  
your **5 year warranty**



Visit [pmc-speakers.com](http://pmc-speakers.com) and click on  
**PRODUCT REGISTRATION** under the **SUPPORT** heading

If you do not have access to the internet fill in the warranty  
form found on pages 35 & 36 and post it to us.

# WARRANTY CERTIFICATE - PART 1

Your Copy  
to KEEP

Please complete and retain this page for your own records

Product

Serial nos

Date of purchase

Dealers name

Dealers address

Town

County

Postcode

Dealers telephone no

Servicing and warranty issues – Please read the following carefully.

**Non UK clients:** Contact your local dealer/distributor for the details of warranty repairs - see [www.pmc-speakers.com](http://www.pmc-speakers.com) and click on 'where to buy' for their details.

**UK clients:** In the unlikely event of a fault occurring with your The Professional Monitor Company Limited (PMC) product firstly contact your dealer where the product was purchased.

Do not return a product to PMC without firstly contacting our technical dept. If the product must be returned for service you will be issued with a 'Returns Authorisation Number'.

If a product is returned to PMC and subsequently is found to have no fault or a non-warranty fault it will be subject to a minimum of £50.00 plus the carriage for its return.

Proof of purchase is required for any claim covered by this warranty.

This product is warranted for a period of 5 years from the date of purchase or upon receipt of 'our copy' overleaf or on-line registration within ten days of purchase or receipt.

The warranty covers defects due to faulty materials or workmanship but does not cover defects arising from accidental damage, misuse or wear and tear. The warranty is void if any attempt has been made by persons not authorised by PMC to dismantle, repair or modify any part of the product.

Products must be returned using original packing material. This warranty does not cover damage in transit.

Note that the cost of the carriage to PMC is not covered by the warranty.

Returned products that are defective that are covered by warranty will be repaired or replaced at the discretion of PMC.

Allow minimum of 14 working days for return of warranty repairs.

This warranty does not effect your consumer rights under statutory law. This warranty is only valid in the United Kingdom.

# WARRANTY CERTIFICATE - PART 2

## Our Copy

Please complete and return this section to us – or simply complete the online registration at [www.pmc-speakers.com](http://www.pmc-speakers.com) and click on **PRODUCT REGISTRATION** under the **SUPPORT** heading

Product
Serial nos
Date of purchase
Purchased from
Your name
Your email address
Your address
Town
County
Postcode/Zip code

Help us improve  
our products  
see over



# YOUR COMMENTS – HELP US IMPROVE

If there is one thing we should change, what would it be?

We value all our client's comments. Please take a moment to help us improve:

Please tell us how your new PMC's perform. Your comments may appear on the customer quotes section for this product on our site. N.B. Don't worry the comments will be anonymous; your personal details will not appear.

What magazines do you read?

HiFi

HiFi Choice

What HiFi

Stereophile

HiFi News

HiFi+

Gramophone

Other

Pro

Future Music

Sound on Sound

Audio Media

Pro Sound News

Resolution

Audiofanzine

IBE

Tape Op

Other

Lifes style

T3

Stuff

GQ

EVO

FHM

Shortlist

Maxim

Esquire

Other

Online

mixonline.com

gearslutz.com

avreview.co.uk

techradar.com

HiFi WigWam.com

What HiFi.com

the-ear.net

Other

We hope you enjoy your latest purchase as much as we enjoyed designing and building them - Thank you.

# INSPECTION CERTIFICATE

Every component employed within a PMC product is measured, tested, matched and recorded by hand. This analysis also applies to the final product to ensure you receive an identical replica of the original reference model.

- Enclosure finish
- Assembly & Wiring
- Driver installation
- Enclosure seal
- Level – Frequency
- Pair matching
- Listening test 1
- Listening test 2
- Final inspection
- Accessory pack
- User Guide



All the above has been carefully checked by the builder of your **twenty5i** series loudspeakers detailed on the front of this user guide.

© 2024 PMC. All rights reserved.

This document should not be construed as a commitment on the part of The Professional Monitor Company Limited (PMC). The information it contains is subject to change without notice. PMC assumes no responsibility for errors that may appear within this document. Information subject to change.

**ATL**, **active twenty5i**, **twenty5i**, **g-weave**, and **Laminair** are trade marks of The Professional Monitor Company Limited.

CE Conformity PMC loudspeakers conform to CE Directive LVD 73/23/EEC and EMC 89/336/EEC.

WEEE European directive - PMC is a member of a National Compliance scheme and have gained the associated certification of compliance and the following registration number from the Environment Agency WEEE/GJ0101WU

WEEE EU Directive

This symbol on the product or in/on its packaging indicates that this product must not be disposed of with other household waste. It is the responsibility of the owner to dispose of waste equipment via a designated collection point for the recycling of waste electrical and electronic equipment. The recycling of your waste equipment is an attempt to conserve natural resources and ensures that it is recycled in a manner that protects human health and the environment. For more information about where you dispose of your waste equipment for recycling, please contact your local waste/recycling authority or the dealer from whom you purchased the product.







**PMC**<sup>®</sup>

T + 44 (0) 1767 686300  
sales@pmc-speakers.com  
www.pmc-speakers.com

PMC Stock Code: 16746  
RefNo: 1309 - Jan 24