

PMC[®]

prophecy

HEAR THE FUTURE







WHAT DRIVES US

At PMC, music really matters: it moves us and gives us the passion for what we do. The company was founded to create loudspeakers transparent enough to convey the whole of music's expressive power, using advanced engineering and a holistic design approach.

That's harder than it sounds: creating loudspeakers that colour the music by adding their own sound is easier, but that's not the PMC way. Sonic neutrality and transparency have always been our obsession, to reproduce music as vividly and faithfully as possible – just as the artist intended.

As we like to say, loudspeakers are where science meets art – we take care of the science so you can connect with the art.

prophecy

Prophecy exemplifies our holistic design philosophy and the culmination of knowledge from designing the professional loudspeakers used to create the music you love.

As innovators, we strive to provide an even greater connection with music, whether you're making a hit record or movie or enjoying music and movies at home. As the name suggests, prophecy predicts how fulfilling home entertainment should be by setting new standards for the speaker size/performance ratio with even greater scale, realism, transparency and musicality. Easy to accommodate, the prophecy series delivers jaw-dropping dynamics, thrilling bass performance and superb sonic pictures like no other design.

Our unique holistic design philosophy considers every design element to eliminate anything that detracts from the ideal musical experience. As in nature, everything should remain in balance – and that's precisely what the prophecy series delivers.

Never has so big a sound been possible from cabinets so compact; the latest iteration of our groundbreaking patented LaminairX air flow technology unlocks the true potential of our signature Advanced Transmission Line (ATL) and supreme new driver design to create vivid audio pictures equal to the room-filling bass.

The prophecy range comprises five models, from the compact yet mighty prophecy1 standmount and slimline prophecy5 floorstander to the three-way prophecy7 and flagship prophecy9, and there's a matching centre channel speaker for multichannel systems, the prophecyC.

There is a model to suit any room and system, fulfilling – and exceeding – the desires of any music or movie lover.

20
YEARS

UNRIVALLED*
twenty year warranty



prophecy5

prophecy7

prophecy1

prophecy9

prophecyC





prophecy1

The smallest prophecy model is packed with innovation, taking even the most testing type of music in its stride. Handbuilt in Britain, it houses the latest iteration of PMC's ATL bass loading, maximised by our proprietary LaminairX airflow technology to provide jaw-dropping dynamics and scale at all listening levels.

The transparency of this weighty compact speaker ensures vocals that captivate and superb resolution of every element of a recording while delivering a cohesive, captivating musical whole. Meanwhile the thoughtful design ensures ease of drive for use with modest and exotic amplification alike, while the timeless design, and real wood finishes will blend with any style of interior. Hidden fixings keep the styling clean, with magnetically attached grilles with an elegant textured fabric weave.

Don't compromise on performance from compact speakers – prophecy1 is the only choice.

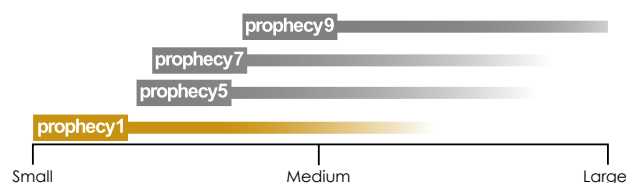

Choosing the right prophecy model for your room size





prophecy1 in Blackened walnut

prophecy5

The unique combination of the custom 5.5-inch prophecy bass driver and an extended Advanced Transmission Line cabinet, paired with cutting-edge LaminairX airflow technology, creates an impressive performance package for its compact size. Its effortlessly powerful, extended bass – the result of the seamless integration of driver, ATL and LaminairX – is perfectly complemented by a custom-made tweeter with meticulously controlled dispersion, allowing it to fill the room with music while delivering pin-sharp stereo imaging.

Taking up no more space than a bookshelf design on a stand, prophecy5 will maximize the performance of even budget-friendly source electronics, and when paired with high-quality amplification will truly shine.

All this comes from a sleek design enhanced with magnetically attached full-face grilles finished in stylish textured fabric, making it both elegant and discreet.

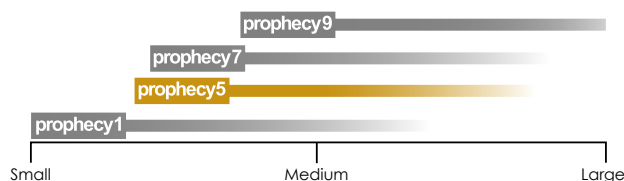

Choosing the right prophecy model for your room size





prophecy5 in Mediterranean oak





prophecy7 in Natural walnut

prophecy7

Once thought to be the preserve of larger speakers, prophecy7's performance and specification set new standards in its class. Mounted within an innovative waveguide, unique to prophecy, the dedicated mid-range driver in this cutting-edge three-way design ensures precise vocal reproduction and thrilling instrumental textures, all delivered with remarkable transparency.

What's more, it enhances overall sound quality by allowing the bass unit and tweeter to focus on their specific frequency ranges, all controlled by a sophisticated hand-built crossover, tuned and honed for ideal driver integration. Complementing this superlative mid-range and treble is our custom bass driver, with the latest Advanced Transmission Line, augmented by the revolutionary LaminairX airflow technology, ensuring this still-compact three-way is both refined and massively powerful.

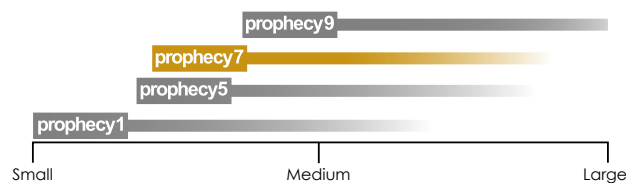

Choosing the right prophecy model for your room size





prophecy7 in Natural walnut

prophecy9

All the prophecy models relay the scale of a music or movie performance way beyond their room-friendly forms suggest, but the flagship prophecy9 will exceed all expectations in terms of soundstage, dynamics and sheer musical enjoyment. The precision soft dome tweeter and supreme 55mm soft dome midrange driver are housed in a profiled baffle with proprietary wave guide technology, giving effortlessly spacious, tangible vocals and beautiful extended high frequencies to define the recorded space.

The pair of custom long-throw bass units, teamed with PMC's Advanced Transmission Line and the revolutionary LaminairX aerodynamic airflow technology, deliver both amazingly extended low frequencies and all the subtle nuances of the bass – all this from whisper quiet levels to truly visceral impact. And while prophecy9 is at home with modest amplification, it will also 'grow' as your system develops – while its sleek styling, with full face grilles attached with concealed magnets, makes even this largest prophecy model a fine match for any room.

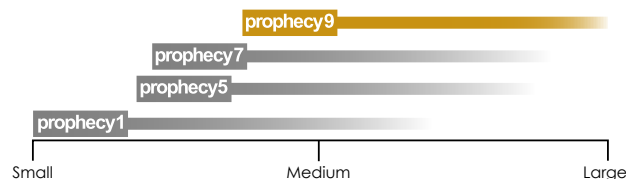

Choosing the right prophecy model for your room size





prophecy9 in Mediterranean oak

prophecyC

At PMC we know about immersive audio: we not only mix in our own studios in London, LA and Nashville, but much of Hollywood's output has also been created using PMC loudspeakers. So we know the exact requirements for the ideal multichannel experience – and that's what the prophecyC delivers.

Like all prophecy models, this centre-channel speaker uses a bespoke Advanced Transmission Line bass loading system, and this version is more complex, making this model an outstanding full-range loudspeaker in its own right. This radical design places the two mid/bass drive units in different positions along the long-folded transmission line, with the remarkable effect of lowering colouration in the vocal region – imperative for dialogue – and enhancing integration with the treble driver. Meanwhile the front-venting LaminairX allows close-to-wall positioning.

As we say at PMC, we build the speakers that make the movies and music: immerse yourself in the drama of a movie, or envelop yourself in multichannel music, with the prophecyC.





prophecy1 and prophecyC in Natural walnut

ONLY PMC
CAN BRING
YOU THIS
CLOSE









prophecy9 in Mediterranean oak

The source of PMC's legendary natural, realistic sound is the Advanced Transmission Line (ATL) bass-loading, which uses the energy generated by the bass driver(s) in the most intelligent and efficient way.

The highly braced cabinet is lined with proprietary acoustic materials to absorb all but the very lowest frequencies. These exit from a front vent, extending the low frequencies to create the response of a far larger and more powerful speaker.

It's not just about bass, however: because the low end is so clean and clear, it doesn't mask the rest of the music, meaning vocals are beautifully projected and ultra-vivid.

There are other benefits too: the bass extension doesn't change with volume level – so even when listening quietly, low frequencies sound rich and well-defined. Moreover, ATL speakers are less dependent on room effects to enhance the bass, making it simple to position them where you want them.

- *More detailed, more natural*
- *Full, rich sound at any volume level*
- *Deeper bass from a smaller cabinet*
- *Ease of positioning*

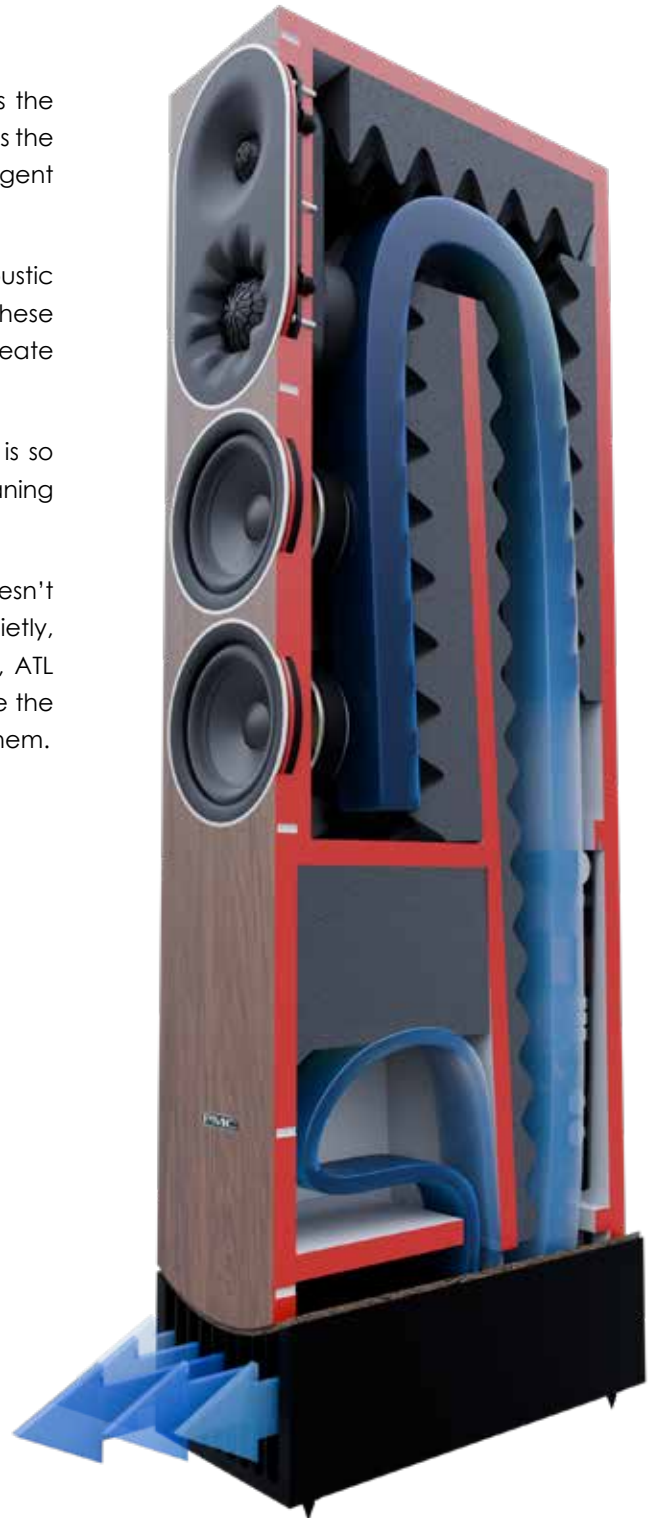

prophecy9 showing ATL in cross-section with Laminair X vent





WHERE AIR MAKES MORE MUSIC

Over a decade since PMC's engineers introduced F1 aerodynamic principles to the audio realm with Laminair, the advent of the prophecy series sees the latest iteration, the patent-protected LaminairX, working in tandem with ATL.

Rarely does anything enter the audio realm with such a profound effect on sound quality and the sheer enjoyment of music: LaminairX unlocks the full potential of PMC's ATL technology. The improvements are both revolutionary technically and, above all, obvious to the listener.

ATL designs involve air moving at high speeds with complex fluid dynamics, and introducing the precision machined ultimate aerodynamic control of LaminairX negates turbulence and drag, which in turn reduces resistance, reduces harmonic distortion by up to 3dB, eliminates air noise and provides bass with superlative timing and an unparalleled dynamic range.

In addition, the weight of the all-metal new LaminairX device, isolated from the main enclosure via a layer of sustainable pure cork, both stabilises and 'anchors' the speaker for even better control.

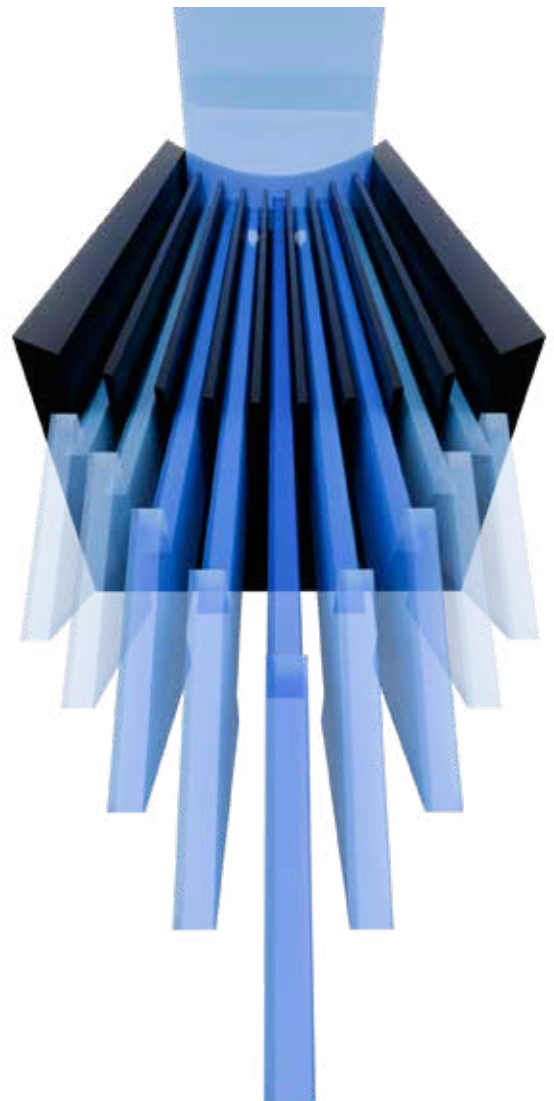

*“The art of clarity,
timing and dynamics,
refined through
science.”*

DRIVEN

Prophecy is all about a vast, natural, room-filling sound, creating a true sense of realism. We have engineered this emotional connection with the music through careful attention to the science and engineering of the speakers, particularly the off-axis performance of our drive units. Not only must they sound perfectly natural, but they must also project their sound like real vocals and instruments: wide, even, and enveloping the whole room.

THE TWEETER

The soft dome high-frequency unit is developed from the tweeter used in our latest cutting-edge professional products, which leading studios use to produce hit music and movies.

This is a precision 26mm soft dome, a chambered design that includes a novel grille that remarkably extends the very top end for a flatter, lifelike response. The mounting chassis allows the coupling of this drive unit to our waveguide technology. Meanwhile, that studio heritage fully assures the driver can withstand the rigours of day-in and day-out use.



THE BIGGER PICTURE

We have achieved legendary status amongst audiophiles and professional music makers alike for our PMC-designed soft dome midrange drivers, allowing the creation and playback of unsurpassed instrumental and vocal recordings, appearing tangible and with vast dynamic range. The PMC55 used in the three-way prophecy7 and 9 has extremely low moving mass, allowing for ultra-low distortion audio reproduction.

As innovators, we constantly research and develop new techniques and technologies to optimise our designs. Using our latest audio modelling software, we have developed a sculpted profile – aptly named n-compass – to surround the high-frequency and midrange drivers, enhancing their response and integration so they act as one drive unit. The result? A seamless, natural balance and near-holographic audio picture wherever you are in the room, creating the sense of ultimate reality for which we're renowned.

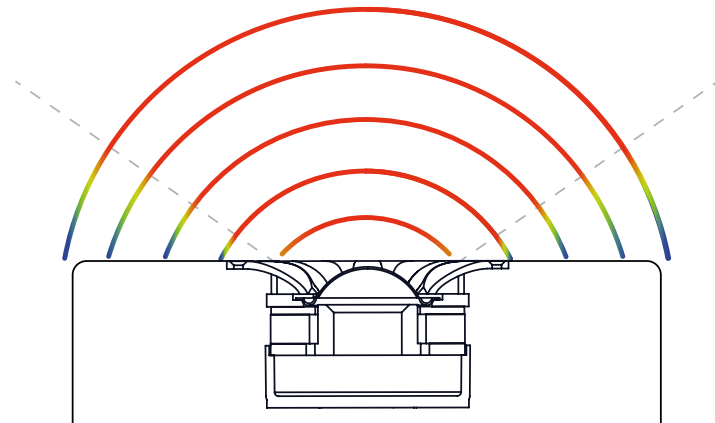

PMC's **n-compass**[™] technology; extends dispersion for a consistent, immersive experience.

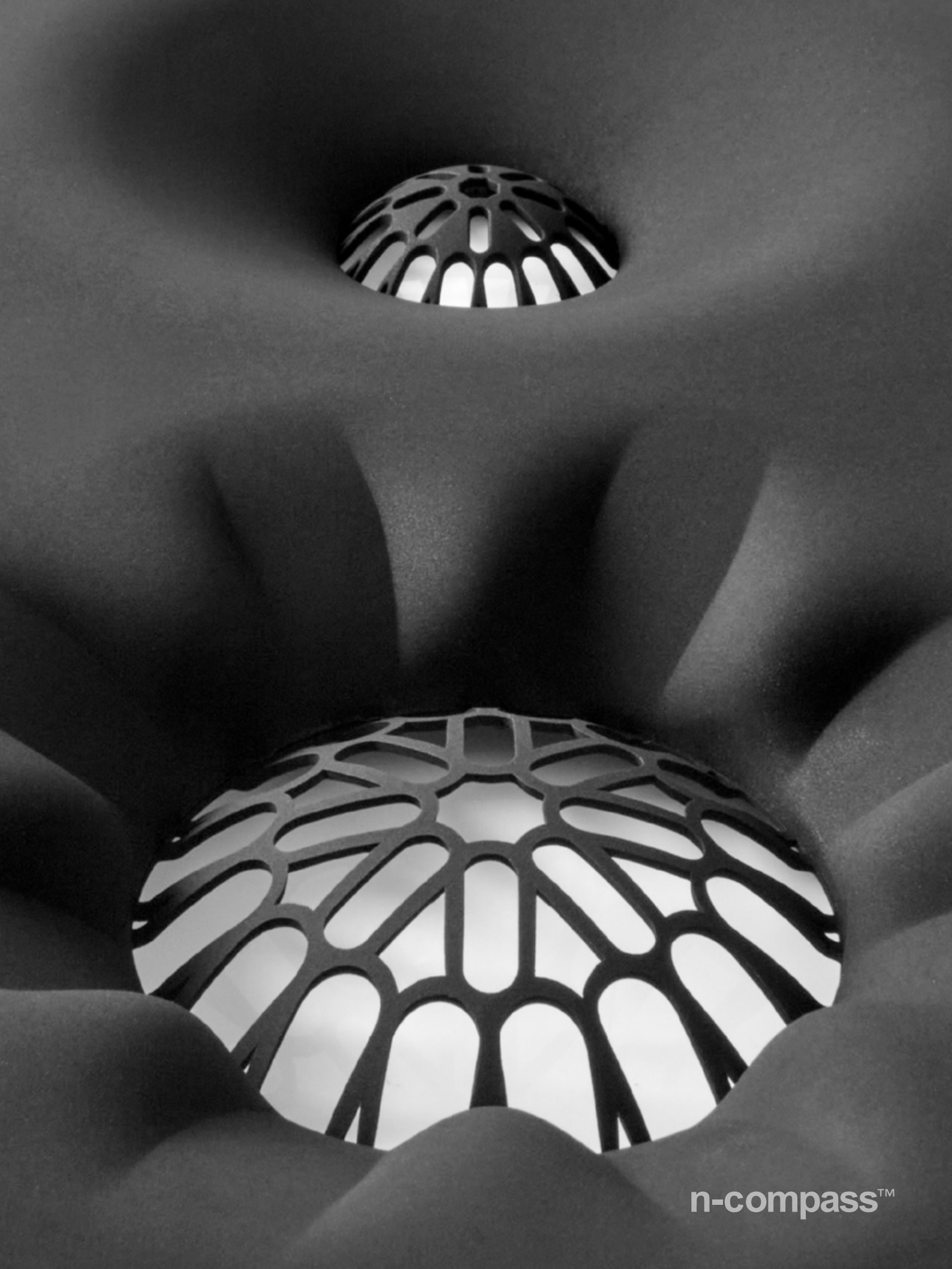

n-compass™

LOW DOWN

The brief for the prophecy range was to create a mid/bass unit that could deliver the deepest frequencies of any piece of music while combining with the sophisticated LaminairX-enhanced ATL cabinets without imparting any colouration in the midrange. It was a tall order, but we achieved it with a powerhouse drive-unit capable of large, rapid excursions and ultra-low colouration, even at the higher frequencies of its range. Its ultralight mica-filled cone material is key to its neutrality, creating the ideal combination of rigidity, damping and weight, allowing it to respond instantaneously to the largest or subtlest audio signals to provide metronomic timing and a beguiling vocal presence.





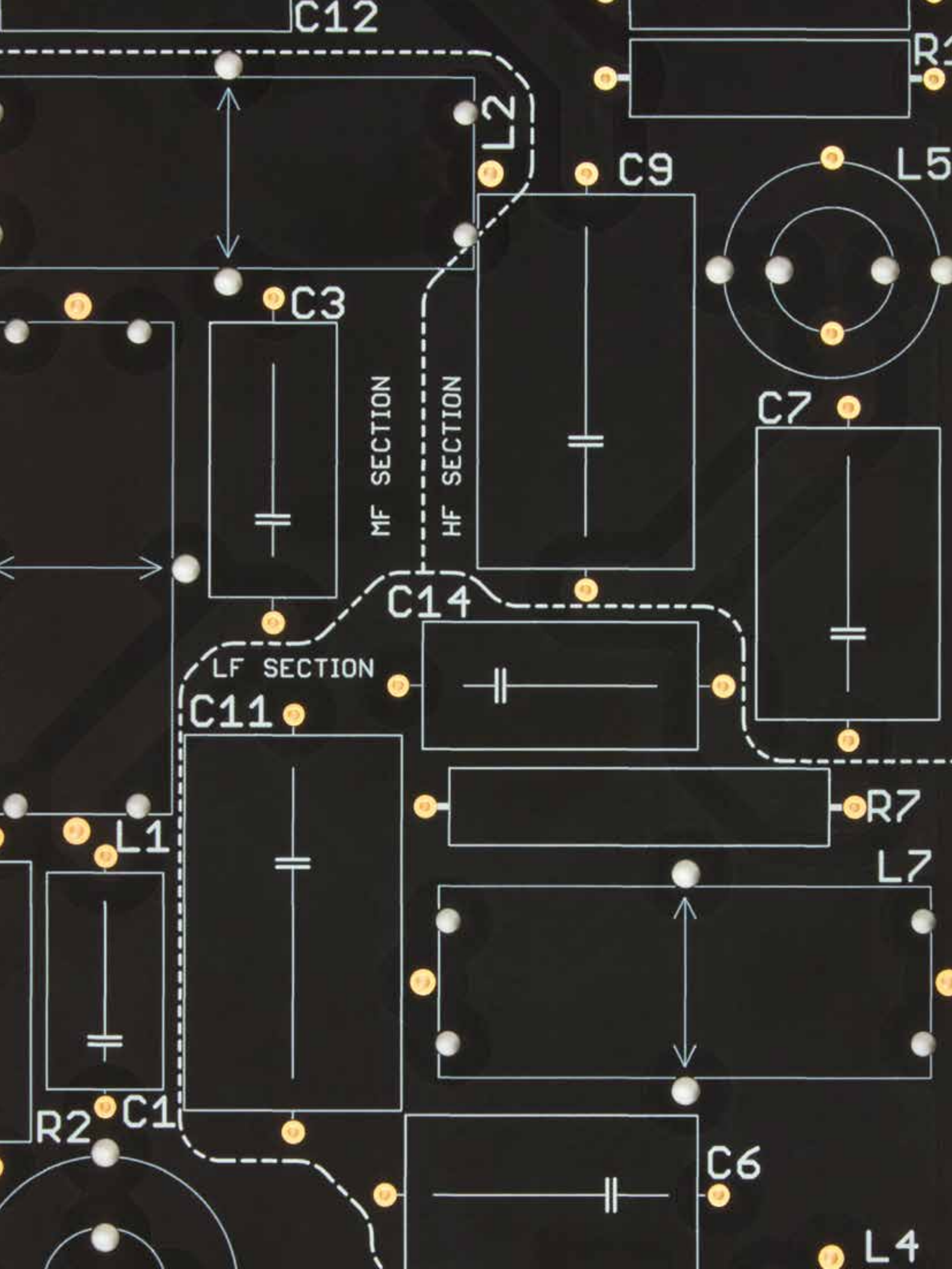

PREMIER DIVISION

The crossover is the heart of the loudspeaker, with the critical task of dividing the incoming signal and distributing the ideal frequencies to each drive unit. Our holistic design philosophy means we consider every element of the loudspeaker's design and its effect on performance, and this can clearly be seen and heard in the meticulous design and tuning of our sophisticated hand-built crossovers.

The foundation is the military-grade, 2.5mm glass-fibre board with the thickest possible conductive copper tracks, keeping resistance low and maximising power delivery to the drive units. Every component is matched and selected at the design stage following careful listening tests, then the chosen ones are hand-soldered to guarantee the best sound quality and reliability. The layout and even the components' orientation and spacing are calculated, and then tuned by ear, to prevent unwanted interactions: the result is supreme-quality components operating to their highest potential, producing the highest level of transparency in the audio output.



prophecy1

Freq. response	50Hz-20kHz (-3dB)
Sensitivity	85dB SPL 1W 1m
Peak SPL	120dB SPL
Rec. amp power	20 - 200W
Effective ATL™ length	1.79m 5.8ft
Impedance	6 Ohm
Drive units	LF PMC 5"/125mm LT ^{XL} mineral cone with cast alloy chassis HF PMC 1"/27mm soft dome
Horizontal directivity	80 degrees
Vertical directivity	90 degrees
Crossover freq.	1.5kHz
Input connectors	One pair 4mm binding posts finished in satin nickel
Dimensions	H 400mm 15.7" W 165mm 6.5" D 260mm 10.2" (+ 23mm terminals and +10mm grille)
Weight	10.3kg 22.7 lbs ea.
Finishes	Mediterranean oak, Natural walnut, Blackened walnut



prophecy5

Freq. response	40Hz - 20kHz (-3dB)
Sensitivity	87dB SPL 1W 1m
Peak SPL	121dB SPL
Rec. amp power	20 - 200W
Effective ATL™ length	1.79m 5.8ft
Impedance	6 Ohm
Drive units	LF PMC 5"/125mm LT ^{XL} mineral cone with cast alloy chassis HF PMC 1"/27mm soft dome
Horizontal directivity	90 degrees
Vertical directivity	110 degrees
Crossover freq.	1.6kHz
Input connectors	One pair 4mm binding posts finished in satin nickel
Dimensions	H 900mm 35.4" (+20mm spikes) W 165mm 6.5" D 260mm 10.2" (+ 23mm terminals and +10mm grille)
Weight	17.7kg 39 lbs ea.
Finishes	Mediterranean oak, Natural walnut, Blackened walnut



prophecy7

Freq. response	40Hz - 20kHz (-3dB)
Sensitivity	88dB SPL 1W 1m
Peak SPL	123dB SPL
Rec. amp power	25 - 250W
Effective ATL™ length	1.91m 6.3ft
Impedance	6 Ohm
Drive units	LF PMC 5"/125mm LT ^{XL} mineral cone with cast alloy chassis MF PMC 2"/55mm soft dome precision midrange HF PMC 1"/27mm soft dome
Horizontal directivity	90 degrees
Vertical directivity	110 degrees
Crossover freq.	0.6kHz & 3.1kHz
Input connectors	One pair 4mm binding posts finished in satin nickel
Dimensions	H 965mm 37.9" (+20mm spikes) W 165mm 6.5" D 310mm 12.3" (+ 23mm terminals and +10mm grille)
Weight	23.7kg 52 lbs ea.
Finishes	Mediterranean oak, Natural walnut, Blackened walnut



prophecy9

Freq. response	35Hz - 20kHz (-3dB)
Sensitivity	91.5dB SPL 1W 1m
Peak SPL	125dB SPL
Rec. amp power	30 - 300W
Effective ATL™ length	2.57m 8.4ft
Impedance	4 Ohm
Drive units	LF 2 x PMC 5"/125mm LT ^{XL} mineral cone with cast alloy chassis MF PMC 2"/55mm soft dome precision midrange HF PMC 1"/27mm soft dome
Horizontal directivity	90 degrees
Vertical directivity	100 degrees
Crossover freq.	0.6kHz & 3.2kHz
Input connectors	One pair 4mm binding posts finished in satin nickel
Dimensions	H 1030mm 40.5" (+20mm spikes) W 165mm 6.5" D 360mm 14.2" (+ 23mm terminals and +10mm grille)
Weight	28.1kg 62 lbs ea.
Finishes	Mediterranean oak, Natural walnut, Blackened walnut



prophecyC

Freq. response	50Hz - 20kHz (-3dB)
Sensitivity	91.5dB SPL 1W 1m
Peak SPL	124dB SPL
Rec. amp power	20 - 200W
Effective ATL™ length	1.79m 5.8ft
Impedance	4 Ohm
Drive units	LF 2 x PMC 5"/125mm LT ^{XL} mineral cone with cast alloy chassis HF PMC 1"/27mm soft dome
Horizontal directivity	90 degrees
Vertical directivity	90 degrees
Crossover freq.	1.6kHz
Input connectors	One pair 4mm binding posts finished in satin nickel
Dimensions	H 165mm 6.5" W 575mm 22.6" D 260mm 10.2" (+ 25mm terminals and +10mm grille)
Weight	16.3kg 36 lbs
Finishes	Mediterranean oak, Natural walnut, Blackened walnut



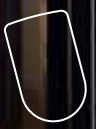
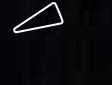
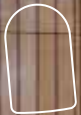



KEEPING IT NATURAL

The prophecy speakers have been designed and engineered for maximum sonic impact, but we've endeavoured to minimise their effect on the environment. The packaging has been designed for recycling, cardboard replacing polystyrene, cloth bags instead of plastic, and the use of non-toxic vegetable-based inks.

And the stylish, tactile, balanced veneers we use on the speakers themselves are sustainably sourced and use minimal processing, ensuring every aspect of prophecy is naturally better. It's the way forward...

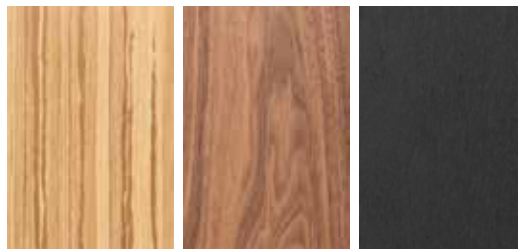

Mediterranean
oak

Natural
walnut

Blackened
walnut





THE PROFESSIONAL MONITOR COMPANY LIMITED

Holme Court Biggleswade SG18 9ST UK
T +44 (0)1767 686300

E sales@pmc-speakers.com W www.pmc-speakers.com

PMC[®]

PMC Stock code 16836 - 12/24