

DS200

STREAMING DAC
OWNER'S MANUAL



FCC Information (For US Customers)

1. IMPORTANT NOTICE:

DO NOT MODIFY THIS PRODUCT

This product, when installed as indicated in the instructions contained in this manual, meets FCC requirements. Modification not expressly approved by McIntosh may void your authority, granted by the FCC, to use the product.

2. CAUTION:

- To comply with FCC RF exposure compliance requirement, separation distance of at least 20cm must be maintained between this product and all persons.
- This product and its antenna must not be co-located or operating in conjunction with any other antenna or transmitter.

3. COMPLIANCE INFORMATION:

- Product Name: DS200 Streaming DAC
- Model Number: DS200
- This product contains FCC ID:2AJYB-S810 and XCO-HSBT075

McIntosh Laboratory, Inc.
2 Chambers Street
Binghamton, NY 13903
Tel. (607) 723-3512

IC Information (Canadian Customers)

1. PRODUCT:

This product contains IC: 20504-S810 and XCO-HSBT075.

This product complies with RSS-210 of Industry Canada. Operation is subject to the following two conditions:

- (1) this product may not cause harmful interference, and (2) this product must accept any interference received, including interference that may cause undesired operation. This Class B digital Apparatus complies with Canadian ICES-003.

2. CAUTION:

To reduce potential radio interference to other users, the antenna type and its gain should be so chosen that the equivalent isotropically radiated power (e.i.r.p.) is not more than that permitted for successful communication.

Informations sur IC (pour les clients Canadiens)

1. APPAREIL:

Cet Appareil contient IC: 20504-S810 et XCO-HSBT075.

Cet Appareil est conforme à la norme CNR-210 du Canada. L'utilisation de ce dispositif est autorisée seulement aux deux conditions suivantes : (1) il ne doit pas produire de brouillage, et (2) l'utilisateur du dispositif doit être prêt à accepter tout brouillage radioélectrique reçu, même si ce brouillage est susceptible de compromettre le fonctionnement du dispositif. Cet Appareil numérique de la classe B est conforme à la norme NMB-003 du Canada.

2. ATTENTION:

Afin de réduire le risque d'interférence aux autres utilisateurs, il faut choisir le type d'antenne et son gain de façon à ce que la puissance isotrope rayonnée équivalente (p.i.r.e.) ne soit pas supérieure au niveau requis pour l'obtention d'une communication satisfaisante.

Canadian Customers: CAN ICES-003 (B)/NMB-003 (B)

RF Exposure Information

This equipment complies with FCC/IC radiation exposure limits set forth for an uncontrolled environment and meets the FCC radio frequency (RF) Exposure Guidelines in Supplement C to OET65 and RSS-102 of the IC radio frequency (RF) Exposure rules. This equipment has very low levels of RF energy that are

deemed to comply without testing of specific absorption ratio (SAR).

Cet équipement est conforme aux normes d'exposition aux radiations FCC/IC définies pour un environnement non contrôlé et satisfait les directives d'exposition à la radiofréquence (RF) dans le supplément C des OET65 et RSS-102 des règles d'exposition à la fréquence radio (RF) IC. Cet équipement a de très faibles niveaux d'énergie RF qui sont jugés conformes sans test de taux d'absorption spécifique (SAR).

RED (EN) Information

1. DECLARATION OF CONFORMITY

Our products follow the provisions of EC/EU directives:

LVD: 2014/35/EU

EMC: 2014/30/EU

RED: 2014/53/EU

ERP: EC regulation 1275/2008 and its framework directive 2009/125/EU

RoHS: 2015/863/EU

2. IMPORTANT NOTICE:

DO NOT MODIFY THIS PRODUCT

This product, when installed as indicated in the instructions contained in this manual, meets RED directive requirements. Modification of the product could result in hazardous Radio and EMC radiation.

3. CAUTION:

Separation distance of at least 20cm must be maintained between this product and all persons.

This product and its antenna must not be co-located or operating in conjunction with any other antenna or transmitter.

Thank You from All of Us at McIntosh

You have invested in a precision instrument that will provide you with many years of enjoyment. Please take a few moments to familiarize yourself with the features and instructions to get the maximum performance from your equipment.

If you need further technical assistance, please contact your dealer who may be more familiar with your particular setup including other brands. You can also contact McIntosh with additional questions or in the unlikely event of needing service.

McIntosh Laboratory, Inc.

2 Chambers Street
Binghamton, New York 13903

Technical Assistance (607) 723-3512
Fax (607) 724-0549

Customer Service (607) 723-3515
Fax (607) 723-1917

Email support@mcintoshlabs.com
Website www.mcintoshlabs.com

Please Take A Moment

For future reference, you can write down your serial number and purchase information here. We can identify your purchase from this information if the occasion should arise:

Serial Number: _____

Purchase Date: _____

Dealer Name: _____

Table of Contents

Performance Features.. .. . 4

General Information 5

Trademark and License Information 5

Front Panel Displays and Switches. 6

Rear Panel Connections and Switches 7

Connectors and Cable Information 8

System Configurations 9

Navigating the Setup Menus 10

System Menu 10-11

 Serial Number: .. . 10

 Firmware Version: .. . 10

 Output Level Adjust: .. . 11

 RS232 Baud Rate Setup: .. . 11

 Auto-Off: .. . 11

 Network Standby: .. . 11

 Max Output: .. . 11

 Stream Control LEDs: .. . 11

 Factory Reset: .. . 11

Input Menu 11

IR Menu 12

 IR Codes Settings: .. . 12

 Front IR Sensor Settings: .. . 12

 Power IR, Input IR, and Trim IR Settings: .. . 12

HDMI Menu. 12-13

 HDMI CEC Settings: .. . 12

 HDMI Lip Sync Mode Settings: .. . 12

 Digital Gain Settings: .. . 13

Trim Functions Menu 13

 Entering Trim Functions Menu .. . 13

 Adjusting Trim Functions .. . 13

 Trim Functions Menu Options .. . 13

 Adjusting Audio Balance .. . 13

 Adjusting Input Trim Levels .. . 13

 Adjusting Brightness .. . 13

Dimensions 14

Using Your DS200 15

 Powering On / Turning Off: .. . 15

 Selecting an Input for Playback: .. . 15

 Adjusting the Level: .. . 15

 MCT Input .. . 15

 Troubleshooting .. . 15

Quick Start Connections. 15-17

 Bluetooth .. . 15

 iOS Device .. . 16

 Ethernet .. . 16

 Wi-Fi .. . 16

 Google Cast .. . 16

 HDMI ARC .. . 17

 AirPlay .. . 17

 Multiroom Audio .. . 17

 Siri Voice Control .. . 17

 Roon .. . 17

 Tidal Connect .. . 17

 Spotify Connect .. . 17

 Qualcomm® aptX™ Audio .. . 17

The Browser Interface. 18

 Overview Menu .. . 18

 Settings Menu .. . 19

 Update Menu .. . 20

Remote Control 21

Specifications 22

Packing Instructions 23

Part List 23

Safety First

Please read the safety instructions included in a separate document called “Important Additional Operation Information Guide.”

Performance Features

- **Built-in casting technologies**

Streaming services such as Spotify® Connect, TIDAL® Connect, Apple® AirPlay®, Bluetooth®, Google Cast, and Roon Ready, let you easily stream to the DS200 from your smart devices.

- **Digital Audio Inputs**

The DS200 has coaxial, optical, MCT DIN, HDMI (ARC), and USB inputs to decode PCM and DSD signals from an external source. The coaxial and optical inputs process digital signals up to 192kHz with 24-bit resolution and decode Dolby Digital and DTS bitstreams. The digital MCT DIN connection allows for streaming of high bandwidth digital signals (DSD, PCM) from external sources. The USB input processes PCM digital signals up to 192kHz with 32-bit resolution, decodes up to DSD512 digital signals and DXD 24-bit with a sampling rate of 352.8kHz (or 384kHz).

- **Alphanumeric Fluorescent Display**

The front panel information display indicates the source selection, sampling frequency, volume level, and setup mode selections. The display intensity is adjustable.

- **Dual Function**

Connect the DS200 to an existing McIntosh analog audio system to provide the latest in digital-to-analog conversion from digital audio sources or use the DS200 as the preamplifier together with McIntosh source components and power amplifier to form a complete audio system.

- **Quad Balanced Digital-to-Analog Converter**

The 8 channel 32-bit digital-to-analog converter is used in a stereo quad balanced mode, assuring the music is reproduced with a wide dynamic range and extremely low distortion.

- **Electronic Input Switching**

Electronic input switching on all inputs provides reliable, noiseless, distortion free switching.

- **Balanced Outputs**

The balanced outputs allow the connection of long cable lengths without a loss in sound quality.

- **Precision Tracking Volume Control**

Volume levels are controlled by a new precision digitally controlled attenuator system with a tracking accuracy of 0.5dB.

- **Remote Control with External Sensor Input**

The remote control provides control of the DS200 operating functions and allows enjoyment of your McIntosh system from another room in your home by connecting an external sensor.

- **Special Power Supply**

Fully regulated power supplies ensure stable noise free operation even though the power line varies.

- **Power Control Input and Output**

A power control connection for powering on multiple McIntosh power amplifiers, source components, and accessories is included for your convenience.

- **Gold Plated Connectors**

The input and output connector contacts are gold plated for superior corrosion resistance and high electrical conductivity.

- **Glass Front Panel with LED Illumination**

The famous McIntosh Glass Front Panel is evenly illuminated by multiple extra-long life Light Emitting Diodes (LEDs) arranged with a special orientation. The pristine beauty of the DS200 will be retained for many years.

- **HDMI TV Sound**

The HDMI ARC (Audio Return Channel) allows you to use your entire audio system to play the sound from your TV, including the over-the-air broadcasts, HDMI inputs, and streaming services.

General Information

The main AC power going to the DS200 and any other McIntosh component(s) should not be applied until all the system components are connected together. Failure to do so could result in the malfunctioning of some or all of the system's normal operations. When the DS200 and other McIntosh components are in their Standby / Power Off Mode, the microprocessor's circuitry inside each component is active and communication is occurring between them.

The unbalanced outputs and the balanced outputs can be used simultaneously.

The DS200 internal digital-to-analog converter circuitry is designed to decode 2 channel PCM (Pulse Code Modulation), Dolby Digital and DTS bitstreams, and DSD (Direct Stream Digital) digital signals present at the coaxial, optical, and USB digital inputs. Other digital audio signal format types will cause the audio outputs of the DS200 to be muted.













The IR input, with a 3.5mm mini phone jack, is configured for non-McIntosh IR sensors such as a Xantech Model HL85BK Kit.

When discarding the unit, comply with local rules or regulations. Batteries should never be thrown away or incinerated but disposed of in accordance with the local regulations concerning battery disposal.

For additional information on the DS200 and other McIntosh products please visit the McIntosh website at www.mcintoshlabs.com.

Trademark and License Information

The McIntosh DS200 incorporates copyright protected technology that is protected by U.S. patents and other intellectual property rights. The DS200 uses the following technologies:

Trademark Logo	License Information
	ASIO is a trademark and software of Steinberg Media Technologies GmbH.
	The terms HDMI, HDMI High-Definition Multimedia Interface, and the HDMI Logo are trademarks or registered trademarks of HDMI Licensing Administrator, Inc.
	For DTS patents, see http://patents.dts.com . Manufactured under license from DTS Licensing Limited. DTS, DTS:X, and the DTS:X logo are registered trademarks or trademarks of DTS, Inc in the United States and other countries. © 2020 DTS, Inc. ALL RIGHTS RESERVED.
	Dolby, Dolby Audio, and the double-D symbol are registered trademarks of Dolby Laboratories Licensing Corporation. Manufactured under License from Dolby Laboratories. Confidential unpublished works. Copyright © 2012-2024 Dolby Laboratories. All rights reserved.
	Use of the Works with Apple badge means that an accessory has been designed to work specifically with the technology identified in the badge and has been certified by the developer to meet Apple performance standards. Apple, and AirPlay are trademarks of Apple Inc., registered in the U.S. and other countries and regions. To use AirPlay with the DS200 Streaming DAC, the latest version of iOS, iPadOS, or macOS is recommended.
	The Spotify Software is subject to third party licenses found here: https://developer.spotify.com/third-party-licenses .
	The Bluetooth® word mark and logos are registered trademarks owned by Bluetooth SIG Inc. and any use of such marks by McIntosh is under license. Other trademarks and trade names are those of their respective owners.
	Qualcomm aptX is a product of Qualcomm Technologies, Inc. and/or its subsidiaries. Qualcomm is a trademark of Qualcomm Incorporated, registered in the United States and other countries. aptX is a trademark of Qualcomm Technologies International, Ltd., registered in the United States and other countries.
	The Wi-Fi CERTIFIED logo is a registered trademark of the Wi-Fi Alliance. Wi-Fi Certification provides assurance that the device has passed the interoperability test conducted by the Wi-Fi Alliance, a group that certifies interoperability among wireless LAN devices.
	Roon Ready network devices have Roon's streaming technology built in, and are certified by Roon Labs to provide the highest level of quality and performance in network streaming.
	This Roon Tested device works over USB and has been profiled by the Roon team to ensure simple setup and effortless daily use.
	TIDAL is the first global music streaming service with high fidelity sound, hi-def video quality, along with expertly curated playlists and original content - making it a trusted source for music and culture.
	Google Cast is a trademark of Google LLC.

Trademarks of McIntosh Laboratory, Inc.:

The following are Registered Trademarks of McIntosh Laboratory, Inc. in multiple jurisdictions around the world: the written McIntosh logo; the McIntosh Globe logo; the Mc logo; Power Guard; Power Guard Screen Grid Sensor; Power Guard SGS; LD/HP; Dynamic Power Manager; the 4DPM8 logo; HXD; the HXD logo; Behind The Sound; Legendary Performance.

The following are Trademarks of McIntosh Laboratory, Inc. in multiple jurisdictions around the world: Autoformer; Sentry Monitor; Solid Cinch; McIntosh Monogrammed Heatsinks; Hybrid Drive; DualView; TripleView; Made of Sound.

The foregoing trademarks, registered and otherwise, are not to be used, reproduced, or registered in any way without the express written permission of McIntosh Laboratory, Inc.

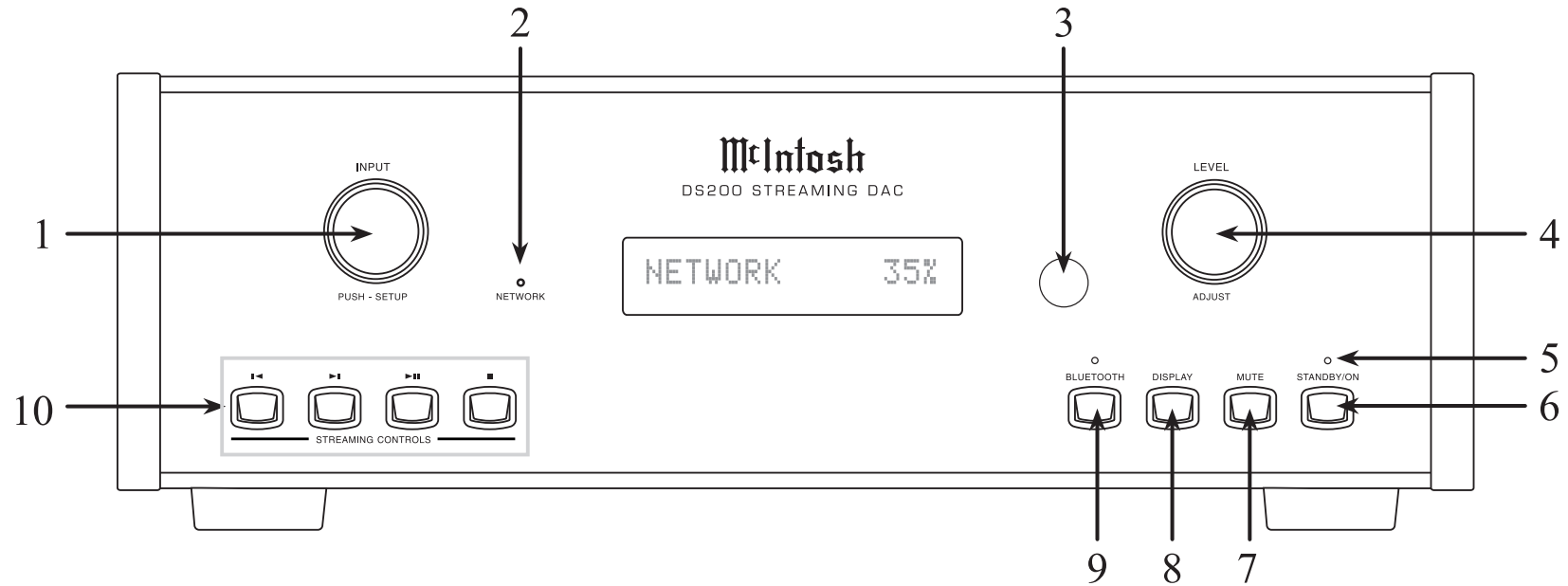

Front Panel Displays and Switches

- INPUT knob** rotates to select different input sources for playback and navigate through different options in the menus. Access menus by holding or pressing the knob in.
- NETWORK LED** will light up in the following ways:

LED	Status
Amber	DS200 is in process of joining the network
Green solid	Connected to the network
Red solid	A network error has occurred
Red slow pulse	Firmware requires an upgrade

- IR Sensor** receives commands from your remote control.

- LEVEL/ADJUST knob** adjusts the output level when “Adjustable” is selected in the setup menu. Also used to navigate in the menus and trims.
- STANDBY/ON Indicator LED** illuminates when the DS200 is connected to AC power.
- STANDBY/ON button** turns the DS200 On and Off.
- MUTE button** will mute and unmute the audio outputs. (Active in Adjustable output mode only.)
- DISPLAY button** will cycle through

the various signal format information, as provided by the connected device or service.

- BLUETOOTH button** places the DS200 into Pairing mode. The LED will flash during Pairing mode, and will light solid when connected to a Bluetooth device.
- STREAMING CONTROLS** allows Play, Stop, Next, and Back soundtrack control with selected streaming services, and of Bluetooth connections. Note: Not every device and connection type allows each control function. The backlite nomenclature serves as a general guide.

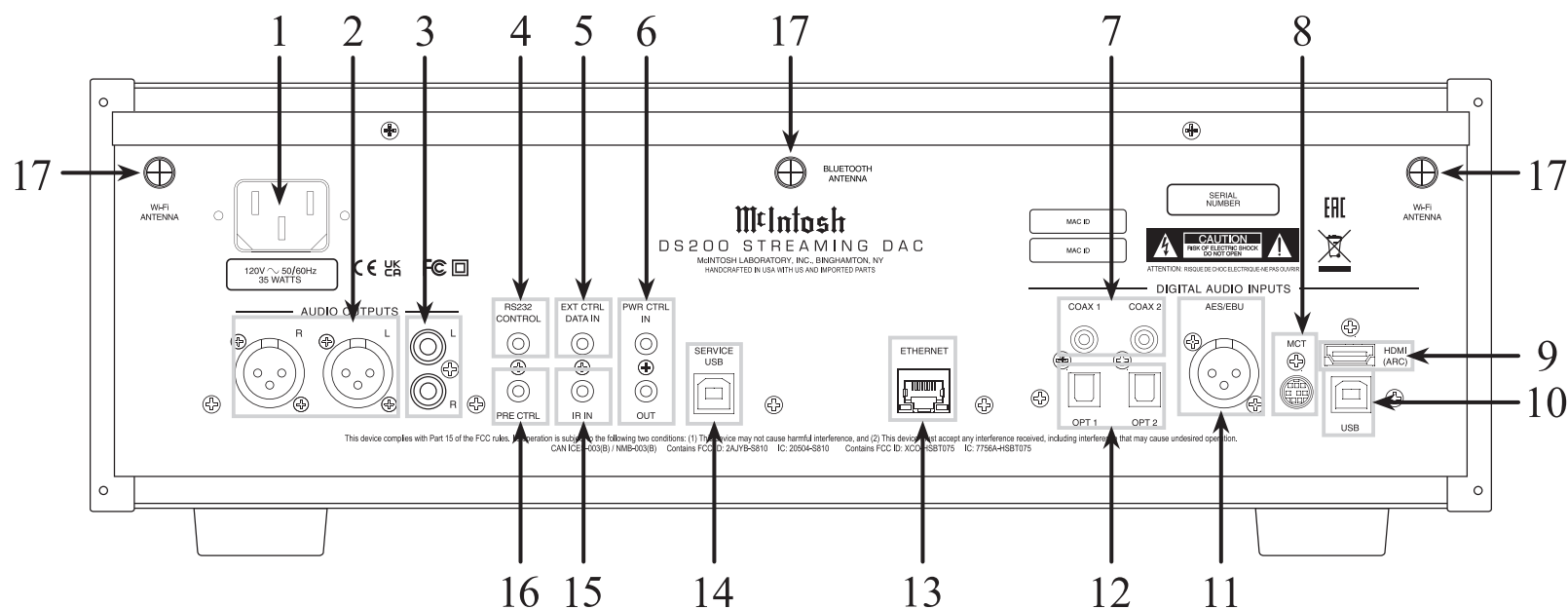

Rear Panel Connections and Switches

- AC Input** uses a Power Cord to connect to an AC Outlet.
- Balanced Outputs** each use an XLR connector cable for a balanced output signal.
- Unbalanced Outputs** use an RCA connector cable for a fixed or adjustable volume level signal.
- RS232 Connector** communicates with external control devices using a 3.5mm stereo mini phone plug cable.
- DATA IN** receives operating data from a McIntosh preamplifier or Control Center.
- Power Control IN** receives turn On/Off signals from another McIntosh component.
Power Control OUT sends a turn On/Off signals to another McIntosh component.
- COAX Inputs (1 and 2)** accept coaxial cables for digital signals.
- MCT Input** transfers signals from McIntosh products with an MCT connector and is required for SACD audio.
- HDMI (ARC) Input** connects with a compatible ARC TV using an HDMI cord to share control and digital audio connectivity. Note: The HDMI ARC functionality of the DS200 is only compatible with ARC TVs. Other devices like DVD and Blu-ray players will not work.
- USB AUDIO Input** is a USB Type-B connector used to connect the DS200 to a computer to stream digital audio.
- AES/EBU** accept balanced XLR connections for digital signals.
- OPTICAL Inputs (1 and 2)** accept optical connections for digital signals.
- ETHERNET Input** for a wired network connection.
- SERVICE USB** is a USB Type-B port used for service purposes only.
- IR Input** connects to an IR receiver using a 3.5mm stereo mini phone plug cable.
- PRE CTRL** reserved for future use.
- ANTENNA - 2 Wi-Fi, 1 Bluetooth**

Connectors and Cable Information

XLR Connectors

Below is the pin configuration for the XLR balanced output connectors on the DS200. Refer to the diagram for connection:

- PIN 1: Shield/Ground
- PIN 2: + Input/Output
- PIN 3: – Input/Output

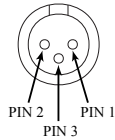

Power Control Connector

The DS200 power control input receives an On/Off signal from +5 to +12 volts. The power control output will in turn provide a +12 volt output signal with a total current up to 25mA. An additional connection is for controlling the illumination of other McIntosh products' meter power output indicators. The 3.5mm stereo mini phone plug connects to a McIntosh preamplifier or A/V control center power control output.

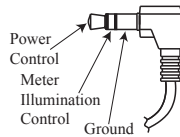

Data Input and IR IN Port Connectors

The DS200 data in port receives remote control signals from McIntosh preamplifiers and A/V control centers. The data out port will send the converted IR commands to another attached McIntosh component. A 3.5mm stereo mini phone plug is used for connection.

The IR in port also uses a 3.5mm stereo mini phone plug and allows the connection of other brand IR receivers to the DS200.

The IR in port also uses a 3.5mm stereo mini phone plug and allows the connection of other brand IR receivers to the DS200.

Note: The IR receiver must provide its own power supply.

The RS232-C Data Cable is a 3.5mm stereo mini phone plug used to connect to external third party controllers.

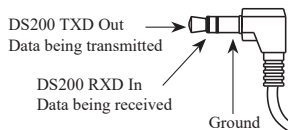
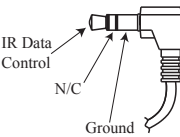
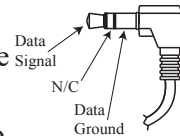

USB Audio

The USB audio input of the DS200 provides the capability to receive music/sound in a digital format from a connected computer.

Software Requirements

Apple® computers with OS-10.6.8 or later require no additional driver install to communicate with the DS200.

For Windows-based computers (PC), Windows 7 (Service Pack 1) or later is required. The correct McIntosh USB audio driver must be installed for the PC to communicate with the DS200.

To install the McIntosh USB driver for Windows-based computers download the latest driver from the McIntosh website: <https://www.mcintoshlabs.com/products/specialty-products/DS200>

The driver can be found in the Downloads section of the webpage under Software Updates. Choose the McIntosh USB Audio Windows Driver. You may select this driver in many third-party applications such as JRiver Media Center.

The DS200's display will show the sampling rate or bit rate for the USB input.

Service USB Port

The service USB port on the rear of the DS200 is for McIntosh service use only. Use the USB audio port for audio input.

Optical

The two optical inputs allow digital sources to be connected to the DS200 using TOSLINK cables also known as "optical audio cables." The optical inputs can handle high resolution digital audio up to 192kHz/24-bit. The DS200 DAC will process standard format SPDIF PCM signals and Dolby Digital and DTS bitstreams. Unsupported formats can result in strange and/or unpleasant sounds.

Coax

The two digital coaxial inputs allow digital sources to be connected to the DS200 using Digital Audio RCA coaxial Cables. The coax inputs can handle high-resolution digital audio up to 192kHz/24-bit. The DS200 DAC will process standard format SPDIF PCM signals and Dolby Digital and DTS bitstreams. Remember, unsupported formats can result in strange and/or unpleasant sounds.

Shown below are two different system configurations. Your system may vary from this, however the actual components would be connected in a similar manner.

Note: The preamplifier or power amplifier may be connected to the DS200 balanced or unbalanced outputs.

System Configuration for DAC Mode

Setup Menu Notes:

- Level Adjust = Fixed (default)
- Front IR = Disabled
- Power IR = Disabled
- Input IR = Disabled

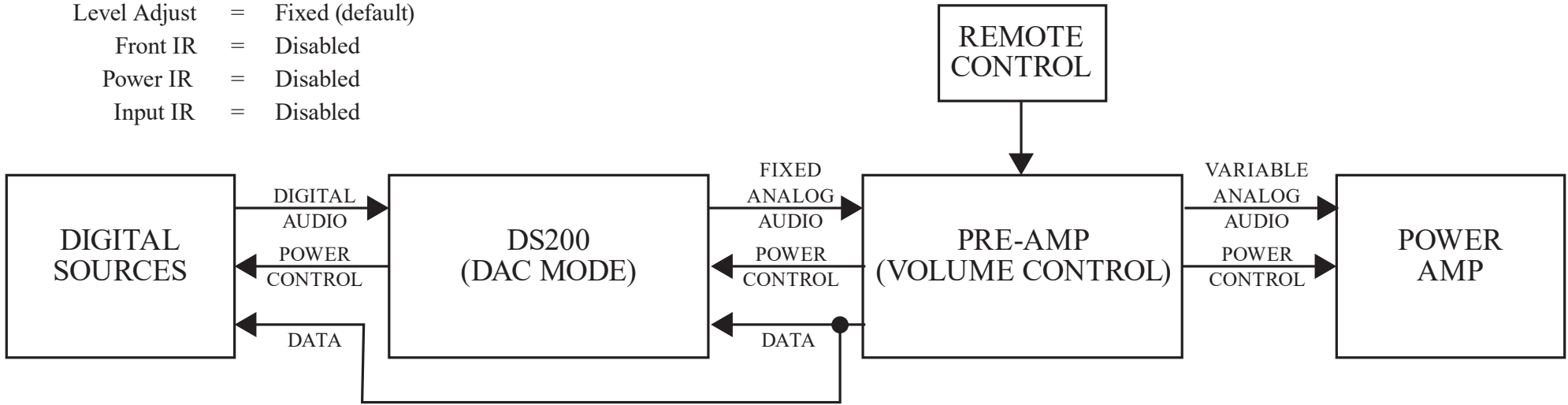

System Configuration for Preamp / DAC Mode

Setup Menu Notes:

- Level Adjust = Adjustable
- Front IR = Enabled
- Power IR = Enabled
- Input IR = Enabled

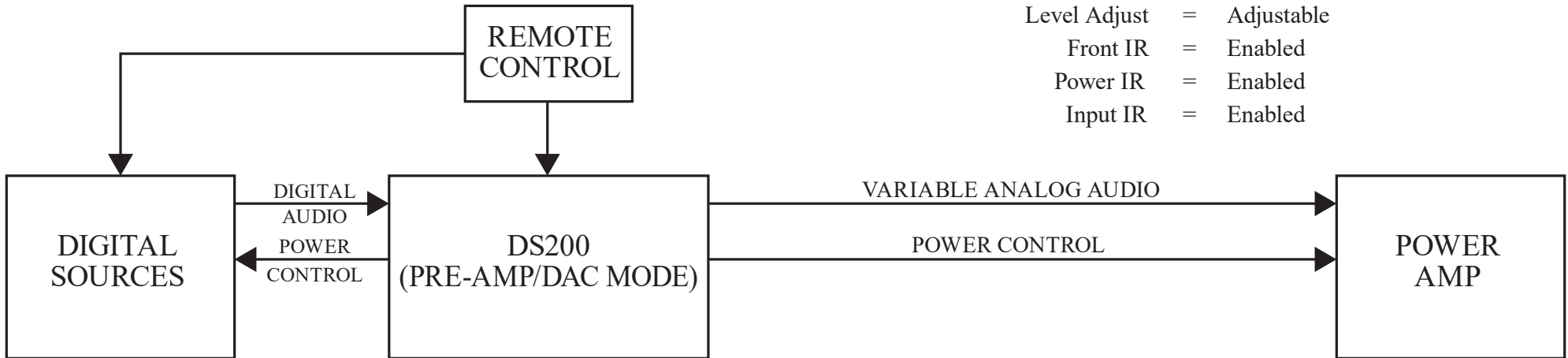

Navigating the Setup Menus

Options:

- SETUP: System Menu
- SETUP: Input Menu
- SETUP: IR Menu
- SETUP: HDMI Menu

Entering Setup Menu:

To enter the Setup Menu, push and hold the INPUT knob. Once the display shows the unit model, the firmware version, and the serial number, release the knob and you are in the setup menu. See next section for the setup menu overview.

Note: “Enter Code” will appear if the INPUT knob is held too long. This is for support purposes only. Press the knob again to exit.

Selecting/Adjusting Menu Settings:

You can navigate through and select the different options in the menus by rotating the INPUT knob. To adjust a selected setting, use the ADJUST knob. If a category in a menu has a submenu available, the display will show “Hold Input”, allowing you to hold down the INPUT knob to see additional options.

Exiting/Navigating Back:

A brief deliberate press (not hold) and release of the INPUT knob will exit the current menu. Make additional presses until the display shows the main operating screen to continue normal use of the unit.

System Menu

The System Menu contains the following information about the DS200.

Setting	Options
DS200 V_._._ S/N AKFxxxx	Version Number Serial Number
WIRELESS Firmware V_._._	Version Number
BLUETOOTH Firmware V_._._	Version Number
Di1 FIRMWARE V_._._	Version Number
SETUP: Level Adjust Setting %	Fixed /Adjustable
SETUP: Fixed Level Setting %	100% - 0%
SETUP: R232 Baud Rate	115200 , 57600, 38400, 19200, 9600 Baud
SETUP: Auto-Off Setting	Enabled /Disabled
Network Standby Setting	Enabled /Disabled
SETUP: Max. Output	1.0, 1.5, 2.0 , 2.5, 3.0, 4.0, 5.0, 6.0, 7.0, 8.0, 9.0 Volts RMS
Stream Ctrl LEDs	Auto , Always On
FACTORY RESET	

*Note: Default settings are marked in **bold**.*

System Menu Settings

The following is a list of the available settings options. A down arrow ↓ represents being taken to a submenu after holding the INPUT knob while the display says “Hold Input”. The selectable options will be listed in brackets [] and separated by commas, with a brief description underneath of what each option does when selected.

Serial Number:

The DS200’s unique serial number can be viewed by entering the setup menu and rotating the INPUT knob until you see “S/N:”. The numbers and letters to the right are the unit’s serial number. This number can also be found on the rear of the unit.

Firmware Version:

Firmware is internal software that controls the DS200’s functionality. Firmware upgrades when available can be installed by qualified technicians. The version of the main firmware of the DS200 can be viewed by entering the setup menu. The first setting is called DS200. The number to the right is the version number. For example, if the VFD displays “DS200 V101”, then the main firmware is version 1.01.

There is also firmware for controlling the digital audio hardware. To see the digital audio firmware version, enter the setup menu and rotate the INPUT knob until you see “Di1 FIRMWARE”. The number following the V to the right is the digital audio firmware version.

System Menu Settings *continued*

Output Level Adjust:

SETUP: LEVEL ADJUST

[FIXED 100%, ADJUSTABLE]

Select the fixed setting for a system where the DS200 DAC will feed a fixed line-level signal into a preamplifier or integrated amp that has its own master volume control under RS-232 control.

Select the adjustable setting when using the DS200 as both a DAC and a preamplifier, to directly feed a power amplifier. In this case the DS200 ADJUST knob will work as the system volume control, or select the Fixed setting and choose the fixed volume output level, 100% to 0%.

RS232 Baud Rate Setup:

The settings for serial communications are:

8 bit, no parity and 1 stop bit

The speed at which the DS200 communicates with devices plugged into the RS232 Port (the Baud Rate) can be adjusted with this Setting.

SETUP: RS232

[rate in bits] Baud

It is recommended to leave this at the highest setting of 115200.

Auto-Off:

SETUP: Auto-Off

[Enabled, Disabled]

Enabled: The DS200 automatically enters Standby Mode after approximately 30 minutes of not playing sound or changing settings.

Disabled: The DS200 will not power off automatically and will remain On until you turn it off.

Network Standby:

SETUP: Network Standby

[Enabled, Disabled]

Enabled: The network and Wi-Fi section will remain powered even when the unit is in Standby mode. This will allow the unit to be remotely activated and turned On by your mobile device or network connected device, like a PC.

Disabled: The Network and Wi-Fi section will not be powered when the unit is in Standby mode, preventing remote activation.

Max Output:

Use to select the output voltage at the analog outputs. 2.0V is recommended when feeding a preamplifier input. A higher voltage can be selected when feeding an amplifier input.

Stream Control LEDs:

In Auto mode the LEDs above the left hand buttons will turn on and off depending on the capabilities of the streaming source. In ON mode the LED's will always be on.

Factory Reset:

Use the factory reset option if you wish to return all settings to factory defaults. All previous setup changes will be lost.

FACTORY RESET

(Hold INPUT knob)

While on this option, hold the INPUT knob until the display says "In Progress!" and immediately release. Once the display says "Completed!", your unit's settings will be set back to their factory defaults.

Input Menu

Setting	Options
COAX 1	On/Name/Off
COAX 2	On/Name/Off
OPTI 1	On/Name/Off
OPTI 2	On/Name/Off
USB	On/Name/Off
MCT	On/Name/Off
HDMI(ARC)	On/Name/Off
NETWORK	On/Name/Off
BLUETOOTH	On/Name/Off

The following changes can be made:

SETUP: Inputs
(Hold INPUT knob)
↓
SETUP: [input name]
[On / Rename, Off]

On / Rename: The selected input will be functioning as normal. Hold in the INPUT knob to enter the menu to rename the input*.

Off: The selected input will be deactivated and will no longer be selectable from the main display during normal use. Change this setting back to "On /Rename" to make it selectable again.

***Renaming Inputs:** While in the selected input's submenu, use the INPUT knob to navigate to the input with the name you'd like to change (and turn it On using the ADJUST knob if it isn't already) so that the display says "SETUP: [input name] On / Rename" and hold the INPUT knob to begin renaming. The character you are currently adjusting will be blinking. Rotate the INPUT knob to select which character you want to change and use the ADJUST knob to change the character.

IR Menu

Setting	Options
SETUP: IR Codes	Normal/Alternate
SETUP: Front IR	Enabled/Disabled
SETUP: Power IR	Enabled/Disabled
SETUP: Input IR	Enabled/Disabled
SETUP: Trim IR	Enabled/Disabled

IR Codes Settings:

SETUP: IR Codes

[Normal, Alternate]

By default, the included HR091 remote control sends “Normal” IR codes when buttons are pressed. Any McIntosh device set to receive “Normal” IR codes will receive the signal. To prevent controlling multiple devices with the remote control at once, change this setting to “Alternate” to prevent signals from the remote control being read. Then an optional remote control like the McIntosh HR085 or HR093 set to alternate codes would control the DS200.

Front IR Sensor Settings:

SETUP: Front IR

[Enabled, Disabled]

You can enable or disable the functionality of the IR sensor to change whether or not the DS200 will accept commands from the remote control. You may want to do this if you have an external IR sensor that operates the DS200 with other devices.

Power IR, Input IR, and Trim IR Settings:

The DS200 can be controlled by another McIntosh unit’s remote control using the data in port. If you want to limit what commands sent by the connected unit affect the DS200 you can use the Power IR, Input IR, and Trim settings.

If you wish to disable input commands coming from the data port or from a connected external IR sensor connected the IR in, enter the setup menu. Select Input IR On or Off by rotating the ADJUST knob.

If you wish to disable trim commands coming from the data port or from a connected external IR sensor connected the IR in, enter the setup menu. Select Trim IR On or Off by rotating the ADJUST knob.

HDMI Menu

Setting	Options
SETUP: HDMI CEC VOL	On/Off
SETUP: HDMI CEC Pwr	On/Off
SETUP: Lip Sync Mode	Auto/Manual
SETUP: HDMI Gain	0dB - +14dB in 1dB intervals
SETUP: OPTI 1 Gain	0dB - +15dB in 1dB intervals
SETUP: OPTI 2 Gain	0dB - +15dB in 1dB intervals

HDMI CEC Settings:

SETUP: HDMI CEC VOL

[ON, OFF]

On: Allows compatible devices to use CEC (Consumer Electronics Control) to control certain functions of the DS200.

Off: Prevents DS200 from being controlled w/ CEC.

SETUP: HDMI CEC PWR

[ON, OFF]

On: Allows compatible devices to use CEC (Consumer Electronics Control) to power On/Off the DS200 or be powered On/Off by the DS200.

Off: Prevents devices from using CEC to power On/Off the DS200 or be powered On/Off by the DS200.

HDMI Lip Sync Mode Settings:

SETUP: Lip Sync Mode

[Auto, Manual]

Auto: The DS200 will automatically synchronize audio signals received through HDMI.

Manual: Disables auto video/audio synchronization through HDMI, allowing you to manually calibrate audio/video sync from connected devices.

Digital Gain Settings:

SETUP: Digital Gain
(Hold INPUT knob)



SETUP: [HDMI, OPTI 1, OPTI 2] Gain
[Volume in dB]

To get more even playback Volume from your connected digital devices, adjust their individual volumes with this setting. The defaults are +0dB for HDMI and +0dB for optical.

Entering Trim Functions Menu

A brief deliberate press (not hold) and release of the INPUT knob will take you to the trim functions menu.

Adjusting Trim Functions

You can navigate through and select the different options in the menus by rotating the INPUT knob. To adjust a selected setting, use the ADJUST knob. The remote control will also adjust these settings.

Note: The balance and input trim settings in this menu will only be adjusted and affect the currently selected input and their configurations will be independently saved.

Trim Functions Menu Options

Settings	Options
Balance	L, Center, R
Input Trim	-6dB to +6dB in 1dB intervals
Brightness	4 Levels Dim → Bright

Adjusting Audio Balance

If you want one loudspeaker to be louder than the other, while on the balance setting, use the ADJUST knob to adjust the meter to whichever channel you wish to be louder. The more filled the meter is under a channel, the louder that channel will get, while the opposite channel will get quieter.

Adjusting Input Trim Levels

Devices connected to the various inputs may be sending audio at varying volumes to the DS200. This could result in uneven playback volume when changing sources. To correct this, you can raise or lower the volume of an input as it enters the DS200 by adjusting its trim level with this setting.

Adjusting Brightness

The front information display can be adjusted for brightness in four levels from dim to bright.

Dimensions

The following dimensions can assist in determining the best location for your DS200.

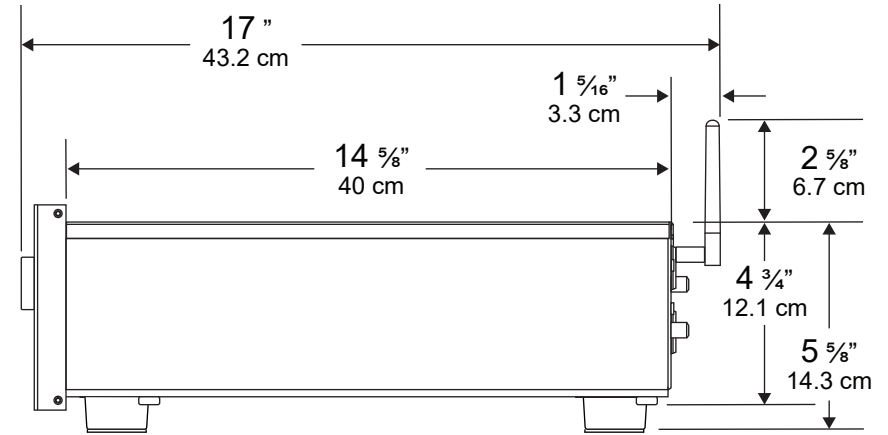
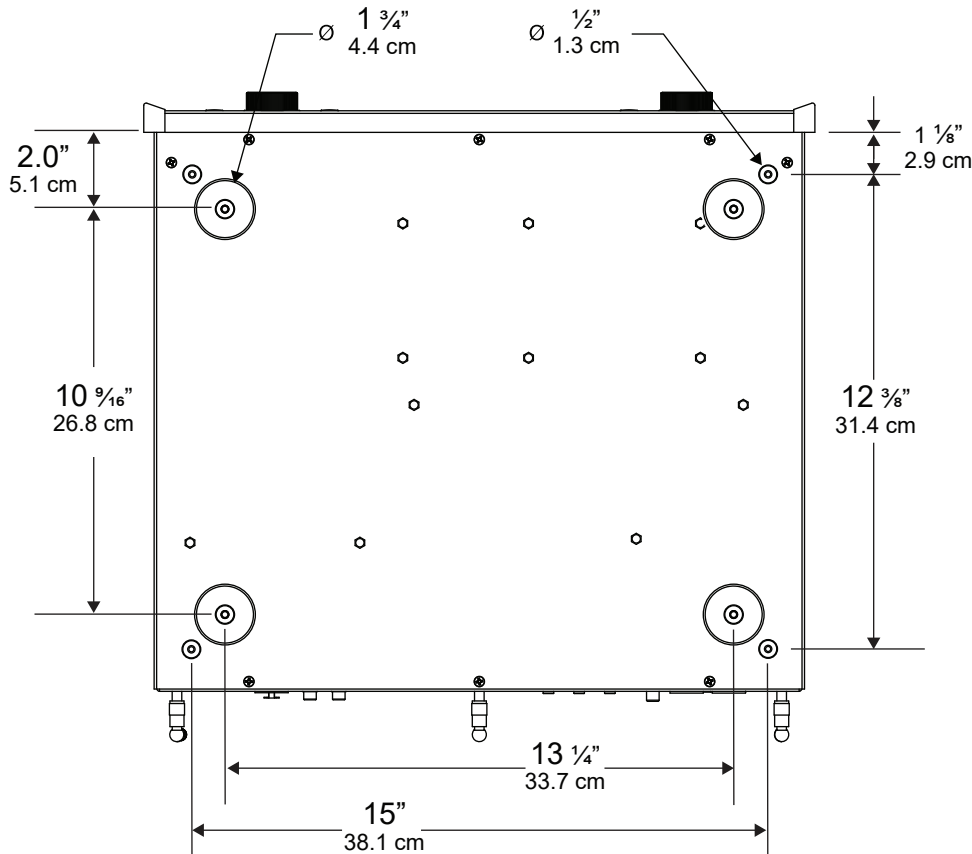
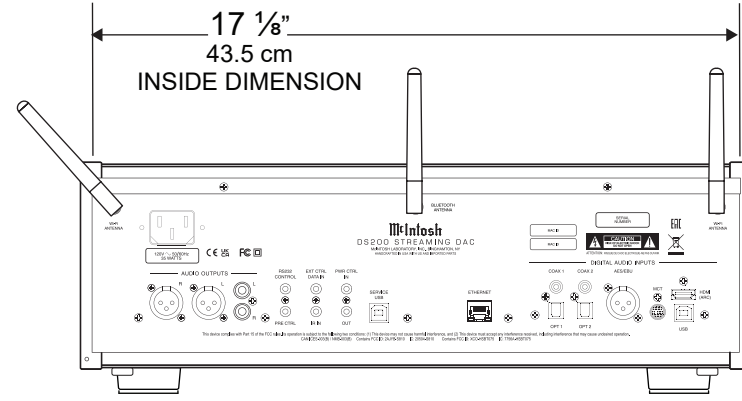
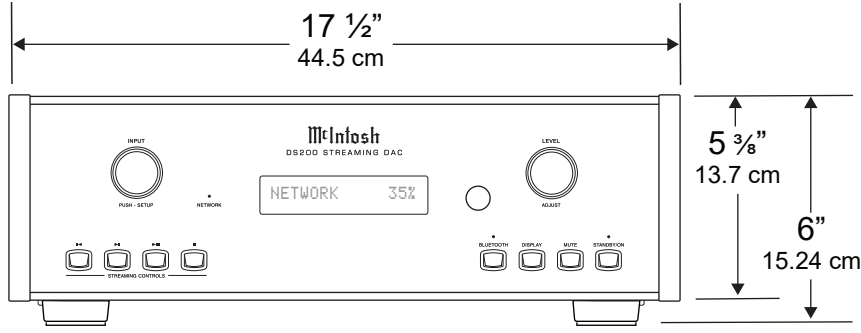

A Note on Placement:

It is important to keep your McIntosh unit out of direct sunlight and only use appropriate gentle cleaners because the organic anodize can become discolored over time. While most products will maintain their classic dark features for their lifetime, some situations can accelerate discoloration. The most pervasive culprit is UV light, especially light directly from the sun, or high intensity spotlights. Even high intensity short-term exposure can result in discoloration.

Chemicals can also alter the finish of the anodize. Aggressive cleaners will take their toll over time and actually etch away the anodize finish.

Using Your DS200

Powering On / Turning Off:

While the unit is in Standby Mode (no lights except the LED indicator light are on), press the STANDBY/ON push button to power on the unit. Power down the unit by pressing the STANDBY/ON button, “Entering Network Sleep Mode” will be indicated on the display as it turns off. Using the remote control, press the power button to turn the DS200 On or Off where appropriate. If power control is connected from a preamplifier, the DS200 will automatically turn on and off with the preamplifier.

The DS200 has the ability to automatically switch power On or Off to source components via the power control connections. The data port connections allow for the remote operation of basic functions using the remote control. With an external sensor connected to the DS200, remote control operation of the system is possible from another room and/or when the DS200 is located in a cabinet with the doors closed.

Selecting an Input for Playback:

You can change the current playback source by rotating the INPUT knob or by using the input button on the remote control.

Adjusting the Level:

If the level setting in the setup menu is set for “Adjustable,” rotate the LEVEL knob or use the volume buttons on the remote control to adjust the volume. The current volume level is represented by a percentage on the display.

Note: The volume control will not affect audio if the level setting in the setup menu is set for “Fixed” level.

MCT Input

When playing a multi-layer SACD, select the stereo (SACD) or CD layer. The multi-channel layer will not reproduce sound.

Note About Initial Network Connection

When your DS200 connects to your network for the first time, it will automatically look for the latest software update. If available, the DS200 will install the newest version. When updating, a message will be displayed on the front panel.

You may adjust how future updates are handled. See “Update Menu” on page 20.

Troubleshooting

In the unlikely event that your commands are not being registered by the unit, you can reset the microprocessors. To do so, hold the STANDBY/ON button down until the LED indicator light switches off. Release the button, and when the light illuminates again, you can press the button again to power the unit On and resume normal operation.

Quick Start (Bluetooth)

Here are the basic steps to start enjoying the DS200 Wireless Loudspeaker System right away. This Quick Start will get sound flowing from the DS200 via a Bluetooth connection. That way you can hear some music as you read the rest of this manual.

1. Connect to the DS200 to AC Power.
2. Power the DS200 On by pressing and releasing the STANDBY/ON button.
3. Press the BLUETOOTH button to select the Bluetooth input. Press and release the BLUETOOTH button again and the display will show ‘Pairing’.
4. On the phone (or other device) you wish to connect, press SCAN in the Bluetooth section of Settings.
5. The DS200 will appear as “DS200 xxxx” in Available Devices.
6. Choose the DS200 to pair
7. When asked to confirm you want to pair the DS200 to your device, select OK
8. The DS200 should now be “Connected for audio”
9. Play some music

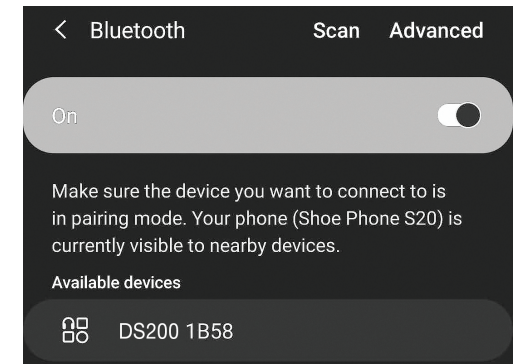

Quick Start (Other Connections)

Wi-Fi connection using an iOS Device

Setting up the DS200 as a AirPlay Speaker will connect the DS200 to your Wi-Fi network:

- Make sure your iOS device is on the Wi-Fi network you wish to connect the DS200 to
- With the DS200 powered on, the NETWORK LED should not be solidly illuminated green (if it were lit, it would indicate the DS200 is currently connected to a network)
- Open up Settings on the iOS device
- Open up the Wi-Fi submenu
- Look at the Wi-Fi network list and find “Set Up New AirPlay Speaker”
- Select the DS200
- The DS200 will be added to your network

Ethernet

For a wired connection to your network, use an Ethernet cable to connect the DS200 to your router.

Note: A solid red Network/Wi-Fi LED indicates that a network error has occurred. See page 6.

Note that plugging in an Ethernet cable will disable the Wi-Fi radio of the DS200. The DS200 will use the Ethernet connection for all network activity. To enable Wi-Fi, the Ethernet cable must be removed.

With an Ethernet connection, you can use the DS200 browser interface to provide the DS200 with your Wi-Fi settings. For more information, see “The Browser Interface” on page 18.

Setting up Wi-Fi Without Ethernet

To initially connect your DS200 to a Wi-Fi network without using an Ethernet connection or iOS connection (as described above) follow these steps:

- Power the DS200 Off and then On
- When the green LED below the Left Knob is blinking, open your PC or phone’s Wi-Fi Connection Settings
- Look for a network name starting with “softAP”
- Open a web browser (Chrome or Firefox)
- Type 192.168.255.249 in the browser’s address bar and press enter and the DS200 interface should open
- Select Settings from the DS200 interface
- Select Wireless in Network Type
- Select Start Scan
- Select your network
- Provide your password and press Connect
- Your DS200 will connect to your network

Google Cast

To Cast to your DS200, you will need:

- The latest version of Google Home App
- Wireless network and access password

With your mobile device/tablet connected to the same Wi-Fi network as your DS200 and the DS200 powered on:

- Open the Google Home App
- Follow the steps for the DS200 if they automatically appear

To manually add the DS200

- Tap the **+** at the top of the screen
- Select “Set up device”
- Select “Setup new devices”
- Follow the set up steps for a “Speaker”

Once the DS200 is setup, you can choose to Cast to it. To Cast:

- Choose the Cast button in the top right corner of a Google Cast-enabled app
- Choose the DS200
- When connected the Cast button will change colors
- Cast music, etc. to your DS200

HDMI ARC

The HDMI ARC (Audio Return Channel) allows you to use your entire audio system to play the sound from your TV.

Notes:

- Ensure you are connected to the TV's HDMI input port that is labeled "ARC".
- Your TV's setup menu and settings may need to be adjusted before sound is heard.
- When the DS200 is set to the HDMI input, the unit will automatically turn On and Off with the TV. The front display will show "Entering HDMI Standby Mode" when turning Off.
- Multi-channel formats will be down mixed to a 2-channel output.

Audio formats supported by HDMI ARC:

- PCM (2 channel)
- Dolby Digital (up to 5.1 channel)
- DTS Digital Surround (up to 5.1 channel)

AirPlay

AirPlay is an Apple technology designed to control home audio systems and speakers in any room – with a tap or by simply asking Siri.

To control this AirPlay-enabled speaker.

Siri Voice Control

Use Siri on your iPhone, iPad, HomePod, or Apple TV to control your DS200 with just your voice.

Roon

When connected to your network, the DS200 will be available as a Zone for your Roon server. (If you have a Roon server.) The DS200 can be connected to your Wi-Fi using AirPlay (see "Wi-Fi connection using an iOS Device" on page 16) or Google Cast. It can also be directly connected with an Ethernet cable.

Tidal Connect

To listen to music on TIDAL through the DS200, using the Tidal app, select the content you want to play and then select the connect icon  on the Now Playing screen.

This will bring up a list of nearby devices to stream through. Locate the DS200 and select to pair.

If you are unable to find your device, make sure the device is connected to the same Wi-Fi network you are streaming from.

Once paired you can use your TIDAL app as a remote. TIDAL is compatible with select smart assistants that enable voice controls. Depending on your region, you may enable this feature by linking your TIDAL account with your selected smart device. This option can normally be found in the Settings section of your respective Smart Devices app.

Spotify Connect

Use your phone, tablet or computer as a remote control for Spotify. Go to spotify.com/connect to learn how.

Qualcomm® aptX™ Audio

aptX™ is a codec that can provide CD quality music over Bluetooth connections. The DS200 will automatically utilize aptX when connected to a source that supports aptX. Simply connect with Bluetooth as described in "Quick Start (Bluetooth)" on page 15.

The DS200 also supports the higher resolution aptX HD (24-bit/48kHz). If your device utilizes aptX HD then that resolution will be utilized automatically.

The DS200 also features aptX LL (Low Latency) which automatically ensures Bluetooth can deliver sound in sync with visual media. It reduces delay and improves end-to-end speed of the audio transmission, resulting in a high quality, synchronized user experience with any transmitting device that supports aptX LL.

The Browser Interface

To view the DS200's browser interface, you will need its IP address.

- Connect your DS200 to a network with either a wired or wireless connection.
- Rotate Input knob until NETWORK is selected.
- Press Front Panel DISPLAY button three times.
- Note the IP address from the DISPLAY window.

With the DS200's IP address:

- Type the address of the DS200 into the address bar of your router

The DS200 Browser interface has three submenus:

- Overview
- Settings
- Update

Click on the desired heading to enter that menu.

Overview Menu

The Overview menu provides the following information about the DS200:

- Serial Number
- MAC Address
- Network IP Address
- Firmware versions

The Overview menu also includes the following settings that can be changed:

- Custom name
- Wi-Fi enabled

Custom Name

You can provide a Custom Name for the DS200. This is the name that will display for available AirPlay devices. If you wish to change the default name, type the new name in the box and press Enter.

Wi-Fi Enabled

The Overview Menu provides an indicator for the status of your Wi-Fi (Wi-Fi enabled). When enabled the indicator will show ON and be green. An Ethernet connection takes precedence and will automatically disable Wi-Fi. Wi-Fi, if set up, will re-engage when the Ethernet cable is disconnected.

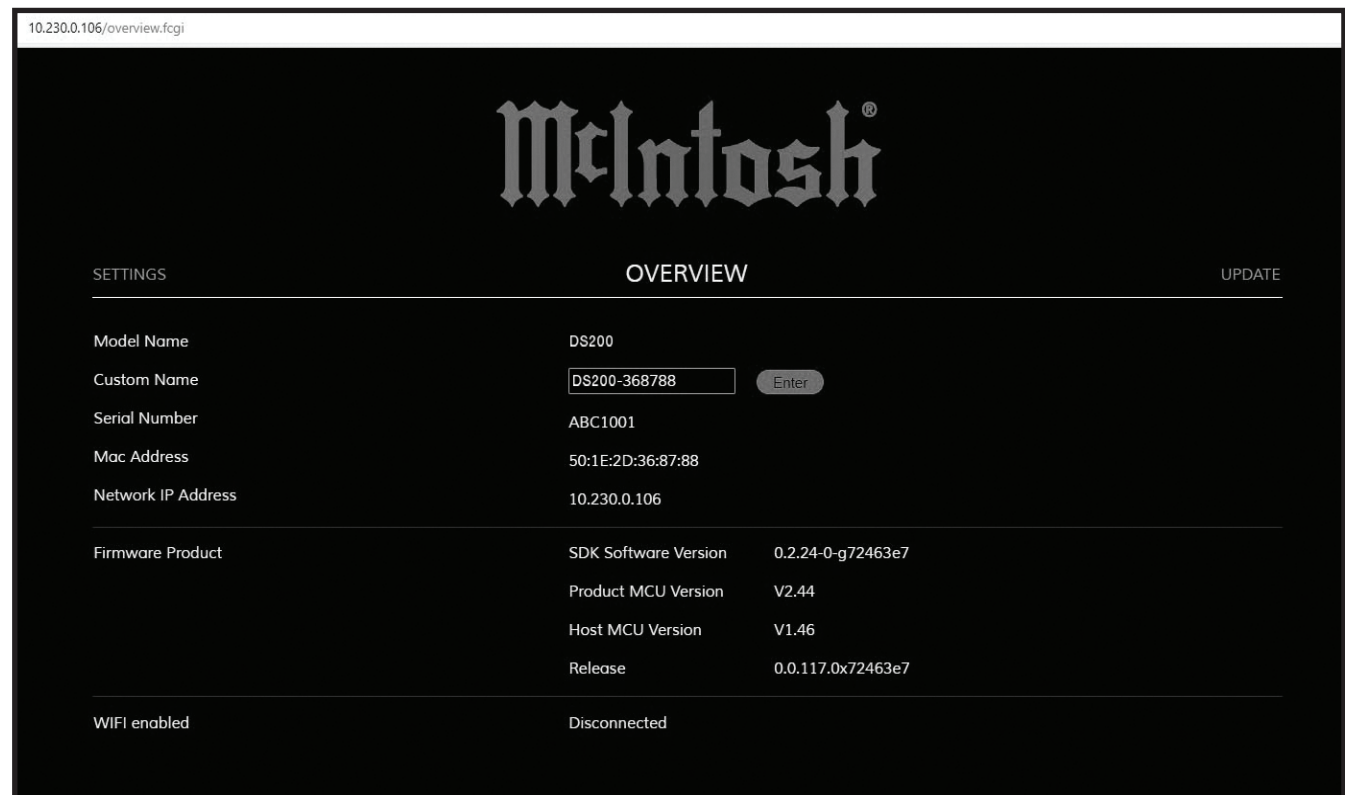

Power Sleep Timer

The Power Sleep Timer has two settings:

- ON (default)
- OFF

The DS200 will power off into a sleep state after approximately 30 minutes of no sound or user input. If Power Sleep Timer is set to ON, the DS200 will enter Standby Mode after 60 minutes of uninterrupted sleep. In this Standby Mode, the Wi-Fi radio is powered off and the unit can not be woken via the network. Standby Mode power consumption is less than 0.5 watts.

If the Power Sleep Timer is set to OFF, the DS200 will power off into a sleep state after 30 minutes of non-activity, but will not enter Standby Mode. The DS200 can be woken from sleep by input from the network (or physically pushing the Power Button). In a sleep state, the DS200 will continue to work with devices configured to control it in your Google Home collection.

The DS200 can be made to immediately enter a sleep state by pressing the STANDBY/ON button.

Startup Volume Limit

The Startup Volume Limit has two settings:

- ON
- OFF (default)

When the Startup Volume Limit is ON, upon power loss or return to play from Sleep or Standby, the first playback of the product will start at a low volume level. When switched to OFF, the product will resume playback at the last volume level.

Network Type

The Settings Menu allows you to change settings for Wired and Wireless network connections.

Select Network Type to see/change settings:

- Automatic
- Wired
- Wireless

If Network Type is set to Automatic, the DS200 will automatically connect to either Wi-Fi or Ethernet depending on what is available as long as they have been setup properly.

If Network Type is set to Wired, the DS200 will limit the network connection to the Ethernet port connection.

If Network Type is set to Wireless, the following submenus appear:

- Scan Networks
- Display SSID
- Network Password

To set up a wireless connection for the DS200:

1. Select Start Scan
2. In the Display SSID submenu, select a wireless network using the up/down arrows
3. Enter the Network Password for that Network
4. Select Connect

DHCP

DHCP can be set to ON (Default) or OFF. If you change this setting to OFF, you will need to provide the following information manually:

- IP
- Netmask
- Gateway
- DNS (1st and 2nd)

With DHCP ON, this information is automatically acquired and the submenus to enter the information are not visible.

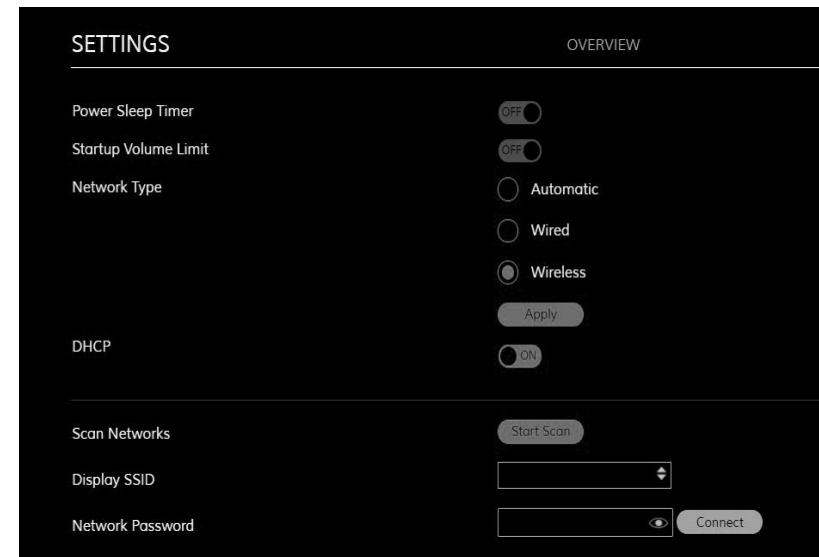

Update Menu

The Update menu allows you to reset settings to the factory defaults as well as update your DS200.

Factory Reset

To restore Factory settings, select the “Start Factory Reset” button.

Note: You will lose your Wi-Fi settings.

An alternative method for Factory Reset can be found in the System Setup Menu, see page 11.

After the DS200 has reset it will be in its sleep state. Press the red STANDBY ON button to wake the DS200 and the front panel display will illuminate.

Update Method

Update Method allows you to set how the DS200 updates its firmware.

The Update Method options are:

- OTA Auto
- OTA Manual
- Service

Note: OTA stands for Over The Air.

When the Update Method is set to the default of OTA Auto, the DS200 will periodically check for updates and install them automatically.

When the Update Method is set to OTA Manual, the DS200 will only check for available updates when you select the **Start Search** button.

If an update is available, you can install it by selecting the **Start Update** button.

The Service option for updating is for service purposes by a McIntosh qualified technician only.

While the DS200 is in the process of updating the firmware, a message will be displayed on the front panel.

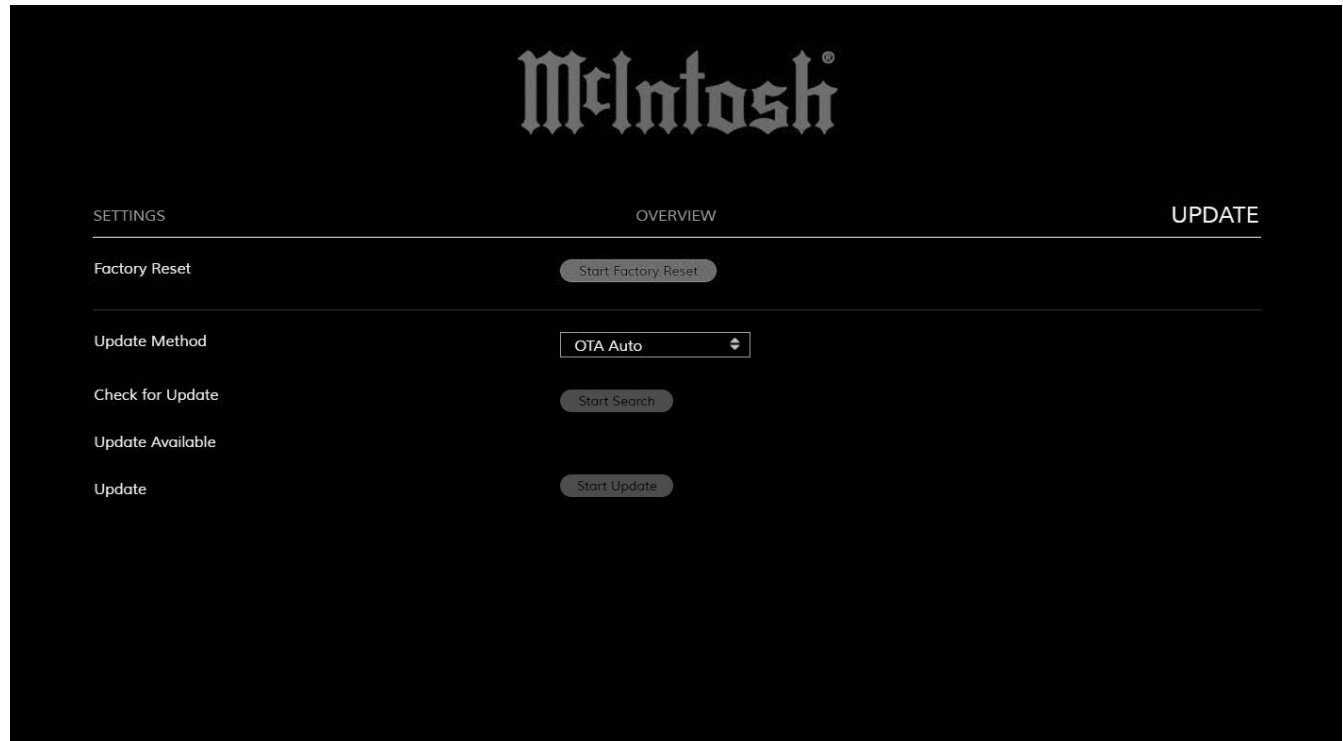

Remote Control Buttons

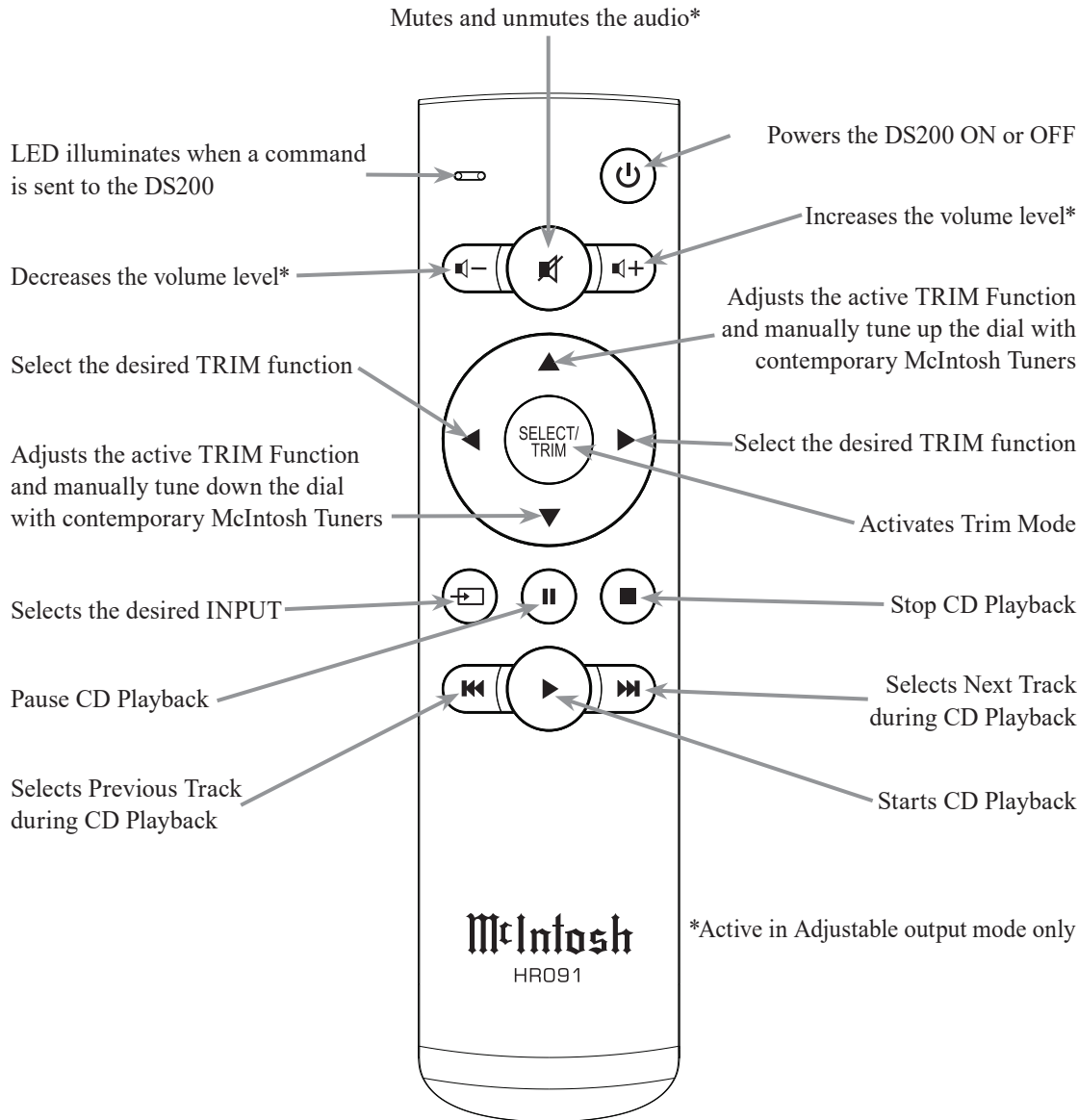

Note: The following additional discrete IR commands for external control systems are available: POWER ON, POWER OFF, INPUT (Down), COAX 1, COAX 2, OPT 1, OPT 2, AES/EBU, USB, MCT, HDMI ARC, Network, and Bluetooth. Contact McIntosh Technical Assistance or your dealer for more information.

Remote Control - Changing the Battery

The back of the remote control is held in place by magnets. To remove the back of the remote to reveal the battery, slide the front of the remote up while sliding the back of the remote down. The goal is to move the back $\frac{3}{16}$ of an inch from the top of the remote and then lift it off.

Open the remote:

1. Hold the remote upside down and backwards with the McIntosh name facing down and away from you. You should be looking at the back of the remote.
2. Pinch the remote with your index finger resting on the SELECT/TRIM button and your thumb on the backside (facing you) opposite your index finger's position. Your thumb and remote should both be pointing away from you.
3. Use your thumb to slide the back open $\frac{3}{16}$ of an inch by sliding your thumb away from you towards the thicker end of the remote, while your index finger goes in the opposite direction (towards you). Make sure you do not hold the side edge with either hand.
4. Lift the back off with your other hand before it snaps closed again.
5. Remove and replace the battery noting the polarity.

Replace the back:

Place the back in position $\frac{3}{16}$ of an inch from the edge. Slide the back towards the top of the remote and the magnets will help you snap it into place.

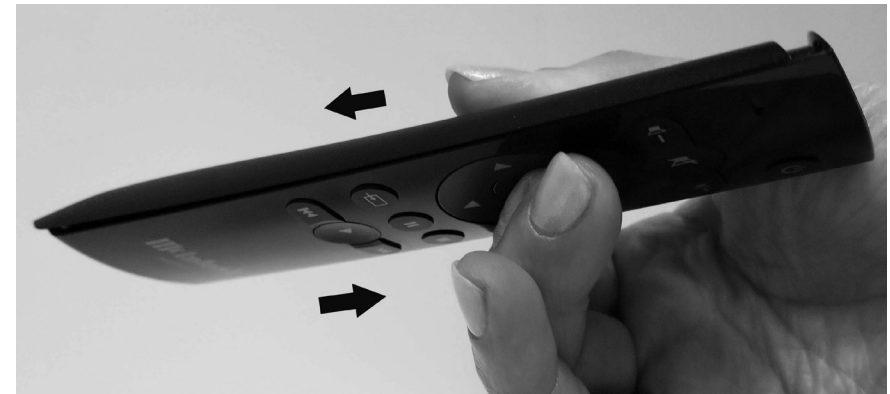

Audio Specifications

Frequency Response

+/-0.5dB from 20Hz to 20kHz
+0.5/-3dB from 5Hz to 60kHz (source dependent)

Total Harmonic Distortion

0.005%

Fixed Output level

2.0Vrms Unbalanced
4.0Vrms Balanced

Adjustable Output level

0 - 8.0Vrms Unbalanced
0 - 16.0Vrms Balanced

Signal To Noise Ratio (A-Weighted)

100dB

Dynamic Range

100dB

Output Impedance

100 ohms Unbalanced and Balanced

Digital Audio Specifications

Digital Input Signal Format

Coaxial and optical inputs - SPDIF (PCM), and bitstream
MCT - SACD, PCM
USB Audio - DSD, DXD, PCM
HDMI - PCM, Dolby Digital, DTS

Digital Input Sample Rates

Optical: PCM 16-bit, 24-bit 44.1-192kHz
Coaxial: PCM 16-bit, 24-bit 44.1-192kHz
MCT: PCM, SACD, 16-bit, 24-bit 44.1-192kHz
USB: PCM 16-bit, 24-bit, 32-bit 44.1-192kHz
DXD DXD352.8kHz, DXD384kHz
DSD DSD64, DSD128, DSD256, DSD512
HDMI: PCM 24-bit, 44.1-192kHz, bitstream

Digital Inputs

Coaxial: 0.5V p-p/75 ohms
Optical: -15dbm to -21dbm (TOS Link)
MCT: 0.5V p-p/75 ohms
USB Audio 2.0: USB Type-B Connector
HDMI: 2.0 ARC

Streaming Support

Apple AirPlay, Google Cast, Spotify Connect, Tidal Connect, Roon

Supported Audio Formats

(Must also be supported by chosen source app and device) MP3, AAC, FLAC, ALAC, WMA, Ogg Vorbis, WAV, M4A, OGG, AIFF

Connectivity

Wi-Fi CERTIFIED™ a, b, g, n, ac
WPA™, WPA2™, WMM®
2.4/5 GHz, Ethernet

Bluetooth 5.0

AVRCP, A2DP, aptX, aptX HD, aptX LL

General Specifications

Power Control Out

12VDC, 25mA

Power Requirements

Field AC Voltage conversion of the DS200 is not possible. The DS200 is factory configured for one of the following AC Voltages:

100 Volts, 50/60Hz at 35 watts

110 Volts, 50/60Hz at 35 watts

120 Volts, 50/60Hz at 35 watts

220 Volts, 50/60Hz at 35 watts

230 Volts, 50/60Hz at 35 watts

240 Volts, 50/60Hz at 35 watts

Standby Power, less than 0.5 watts

Note: Refer to the rear panel of the DS200 for the correct voltage.

Overall Dimensions

Width is 17 ½ inches (44.5cm)

Height is 6 inches (15.2cm) including plastic feet

Depth is 17 inches (43.2cm) including front knobs and rear antennas

Weight

20.5 pounds (9.3 kg) net, 27.5 pounds (12.5 kg) in shipping carton

Shipping Carton Dimensions

Width is 25 inches (63.5cm)

Height is 12 ¼ inches (31.1cm)

Depth is 26 ¾ inches (67.9cm)

Packing Instructions

In the event it is necessary to repack the equipment for shipment, the equipment must be packed exactly as shown below.

It is very important that the four plastic feet are attached to the bottom of the equipment. This will ensure the proper equipment location on the bottom pad. Failure to do this will result in shipping damage.

Use the original shipping carton and interior parts only if they are all in good serviceable condition. If a shipping carton or any of the interior part(s) are needed, please call or write Customer Service Department of McIntosh Laboratory. Refer to page 3. Please see the Part List for the correct part numbers.

Part List

<u>Qty</u>	<u>Part Number</u>	<u>Description</u>
1	033838	Shipping Carton
1	033725	Top Pad
1	033836	Inner Carton
1	034576	Bottom Pad
4	034669	Foam End Cap
4	017937	Plastic Feet

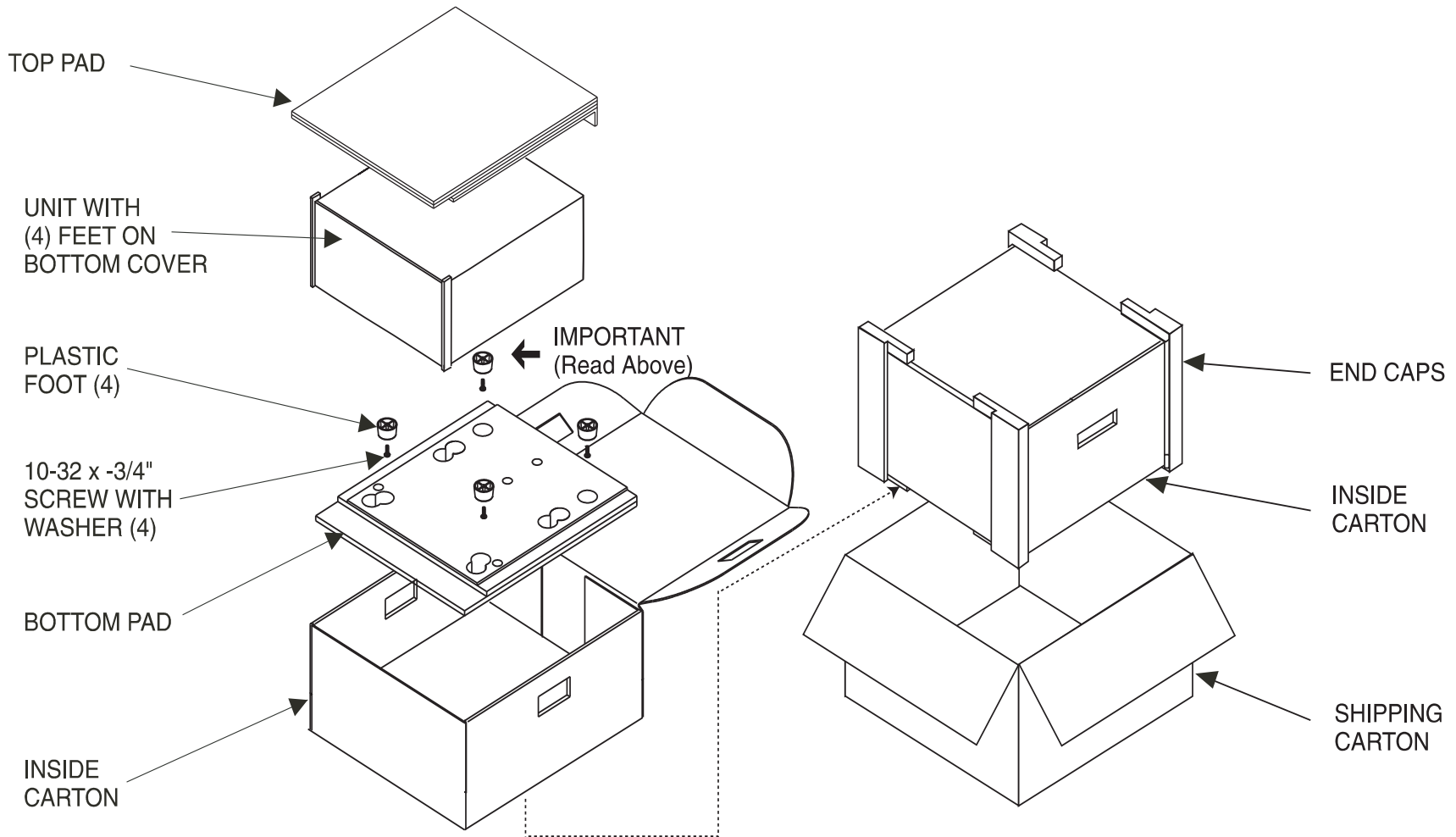

McIntosh®

MADE OF SOUND™

McIntosh Laboratory, Inc.
2 Chambers Street
Binghamton, NY 13903
www.mcintoshlabs.com

The continuous improvement of its products is the policy of McIntosh Laboratory Incorporated who reserve the right to improve design without notice. The DS200 is designed to employ non-McIntosh-provided services some of which require separate customer subscriptions and some of which do not, as part of the Product's functionality. Because McIntosh cannot control the providers of such services or the services themselves, the owner of the Product therefore assumes all risks related to the use of services provided by anyone other than McIntosh itself. McIntosh cannot and does not warrant against, and shall have no liability of any kind for any of the following that are attributable to non- McIntosh providers or services: (i) interruption, discontinuance, or other unsatisfactory performance of service; (ii) reduced Product functionality that is so attributable; or (iii) any other loss or damage of any kind that is so attributable.

Printed in the U.S.A.

© 2025 McIntosh Laboratory, Inc.

McIntosh Part No. 24114501